

Stitching: Model RIG, sofa,
220 x 100 cm in leather, #300-220

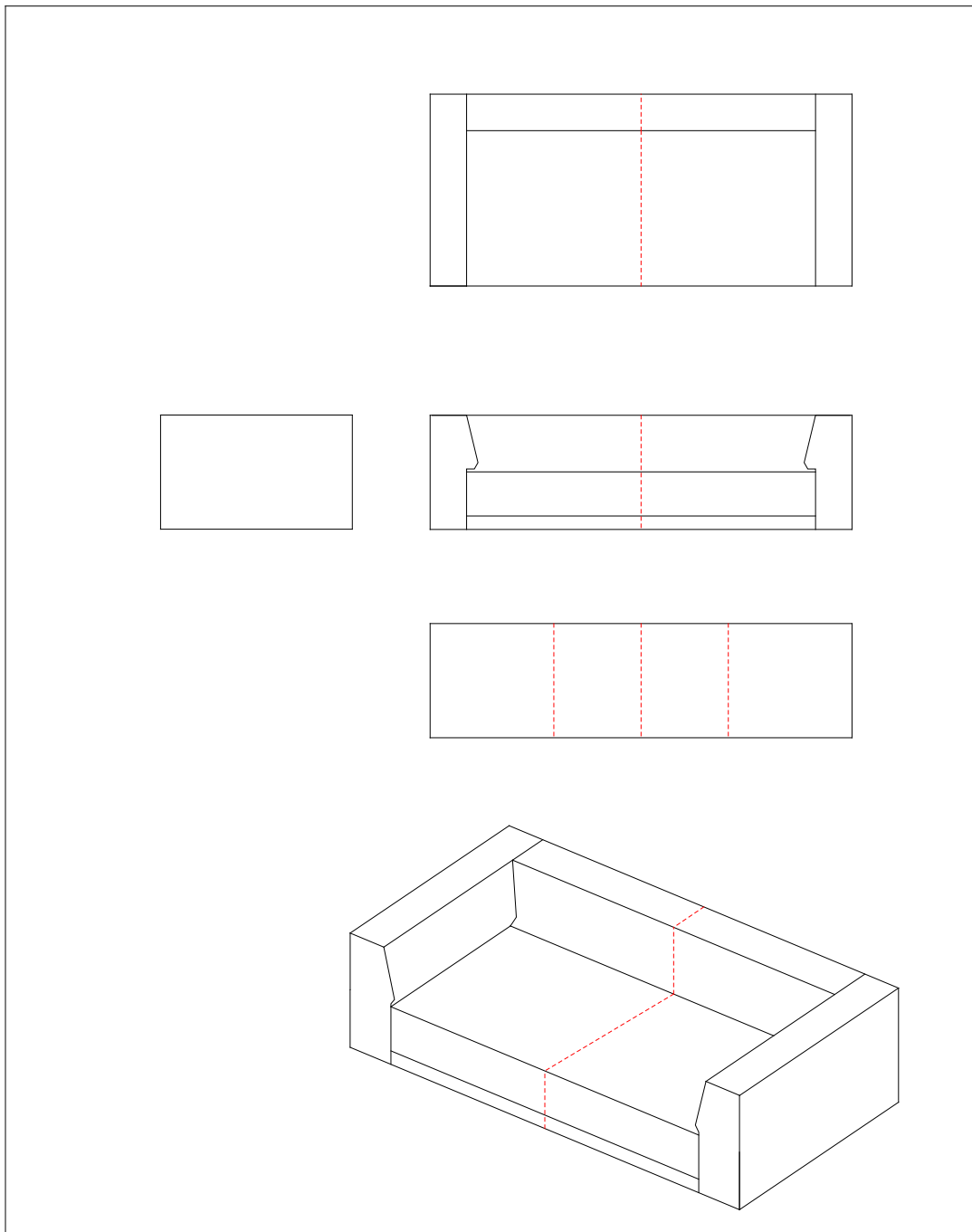

Stitching: Model RIG, sofa,
230 x 100 cm in leather, #300-230

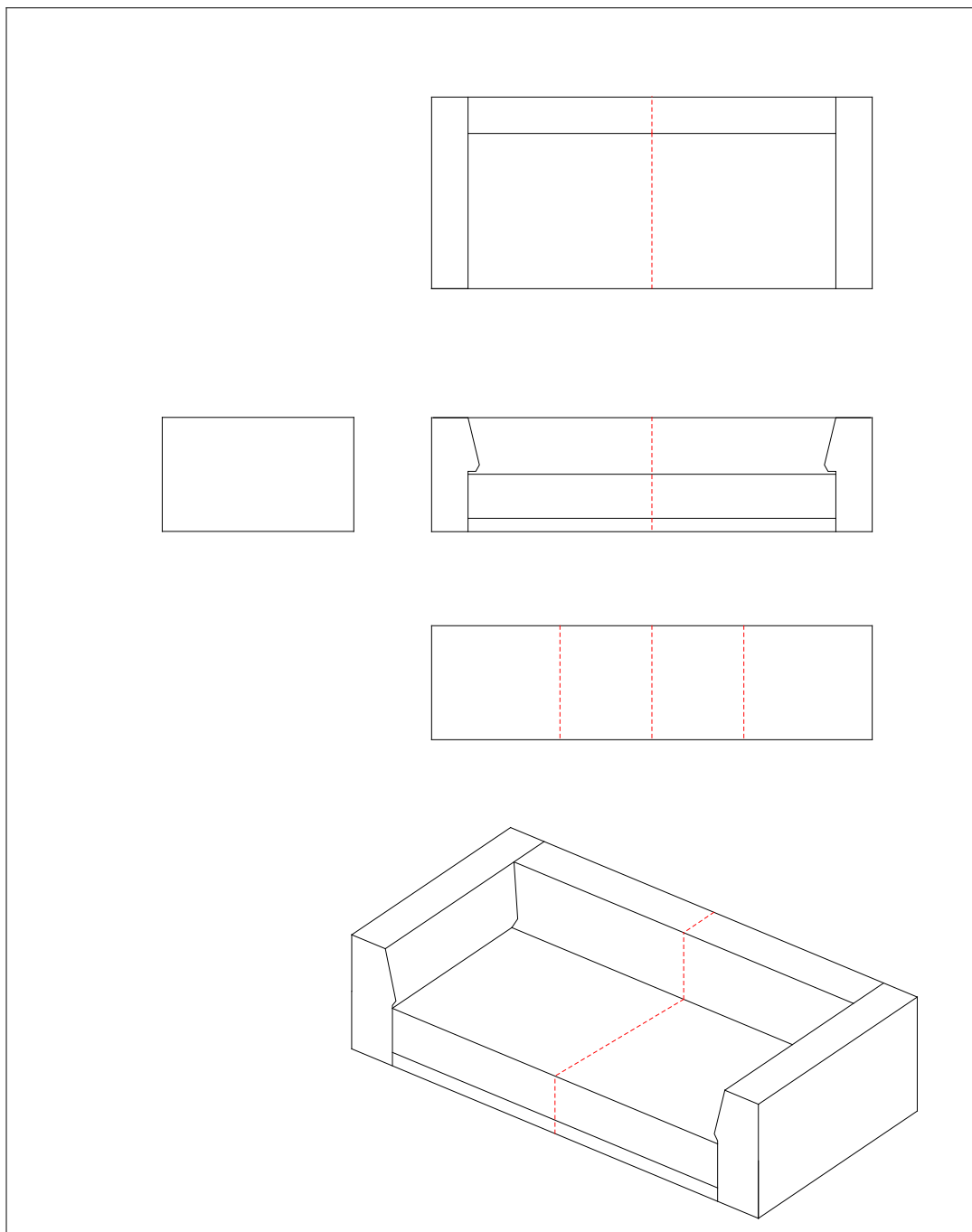

Stitching: Model RIG, sofa,
240 x 100 cm in leather, #300-240

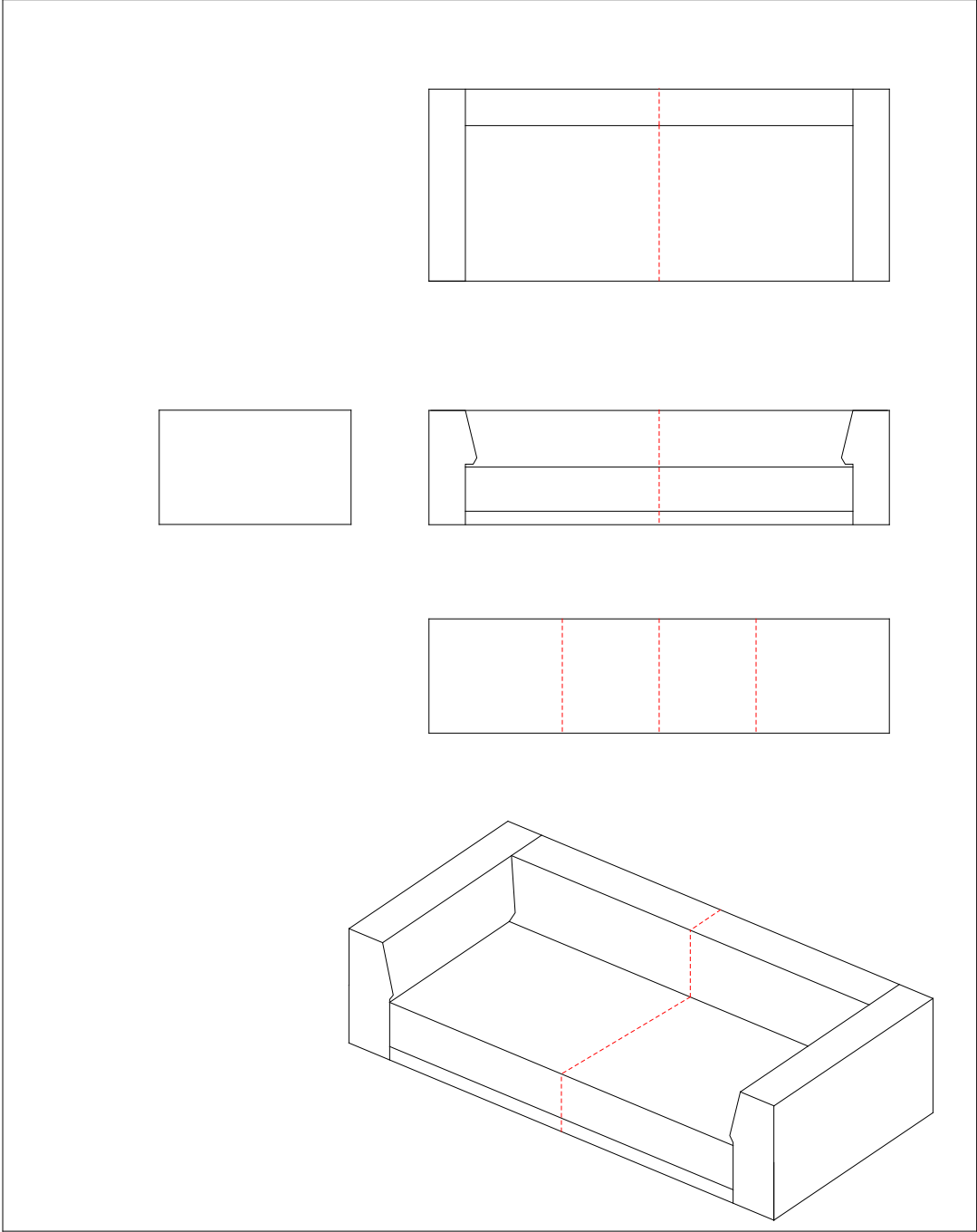

Stitching: Model RIG, corner section,
100 x 100 cm in leather, #300-100

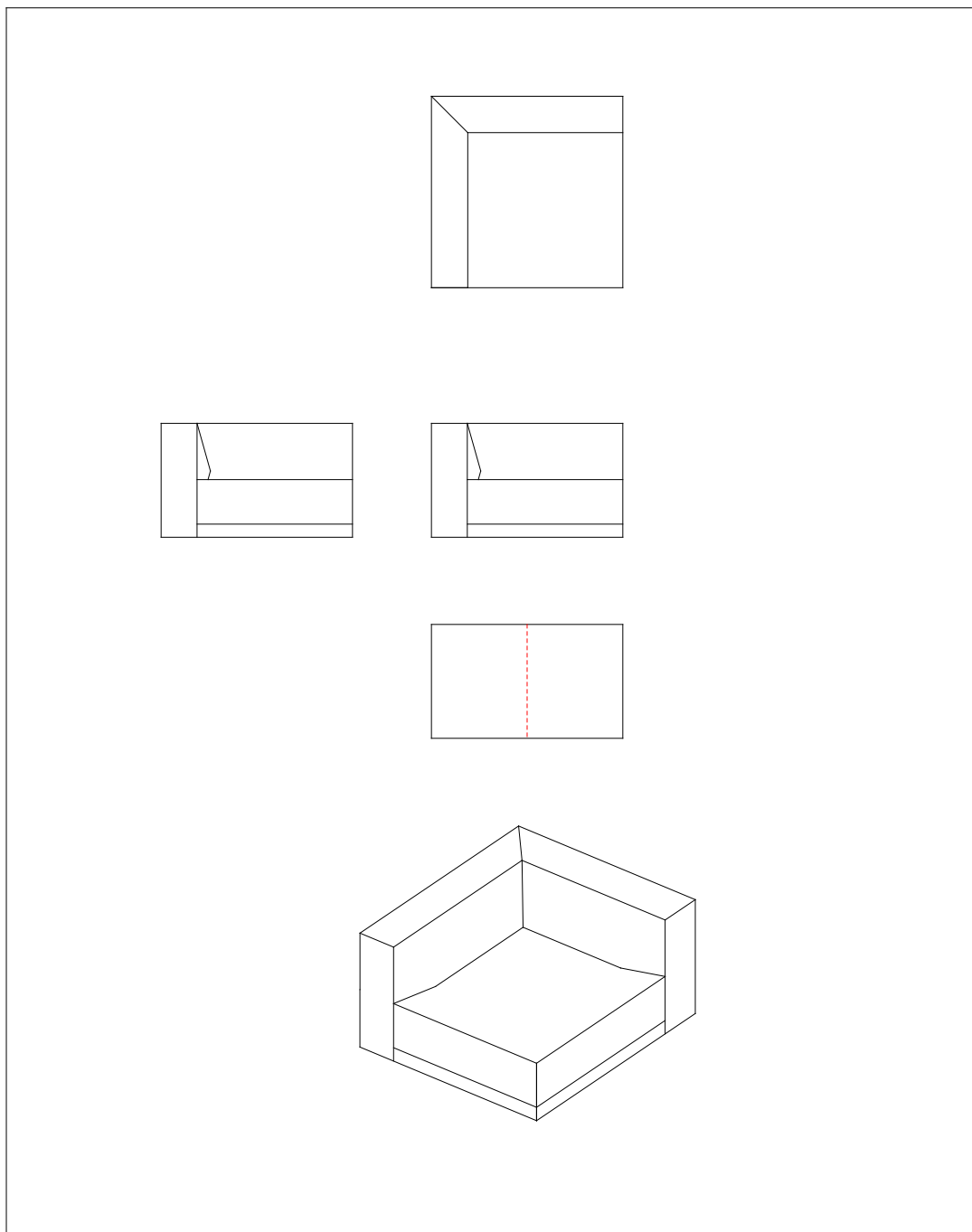

Stitching: Model RIG, center section,
100 x 100 cm in leather, #301-100

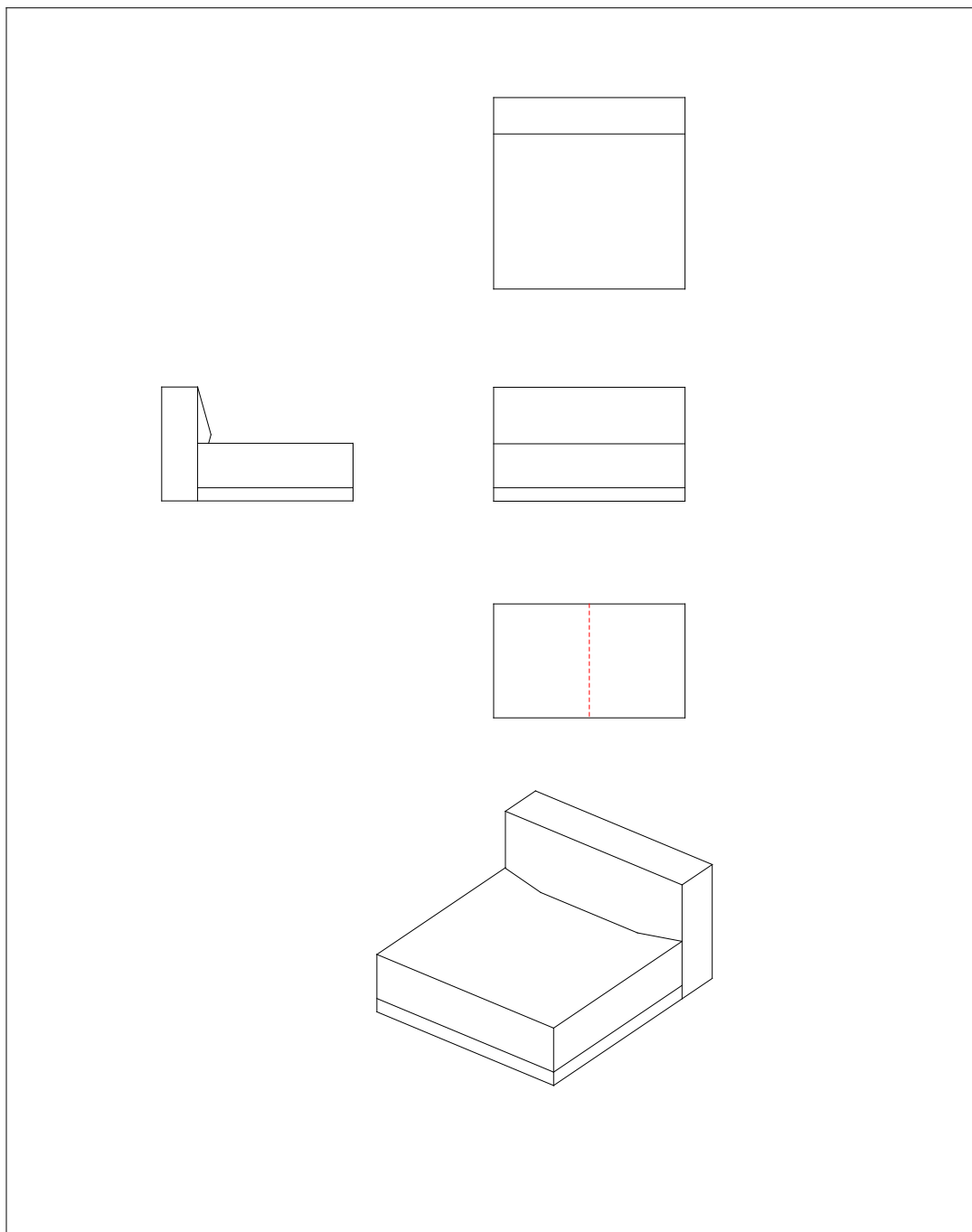

Stitching: Model RIG, center section,
110 x 100 cm in leather, #301-110

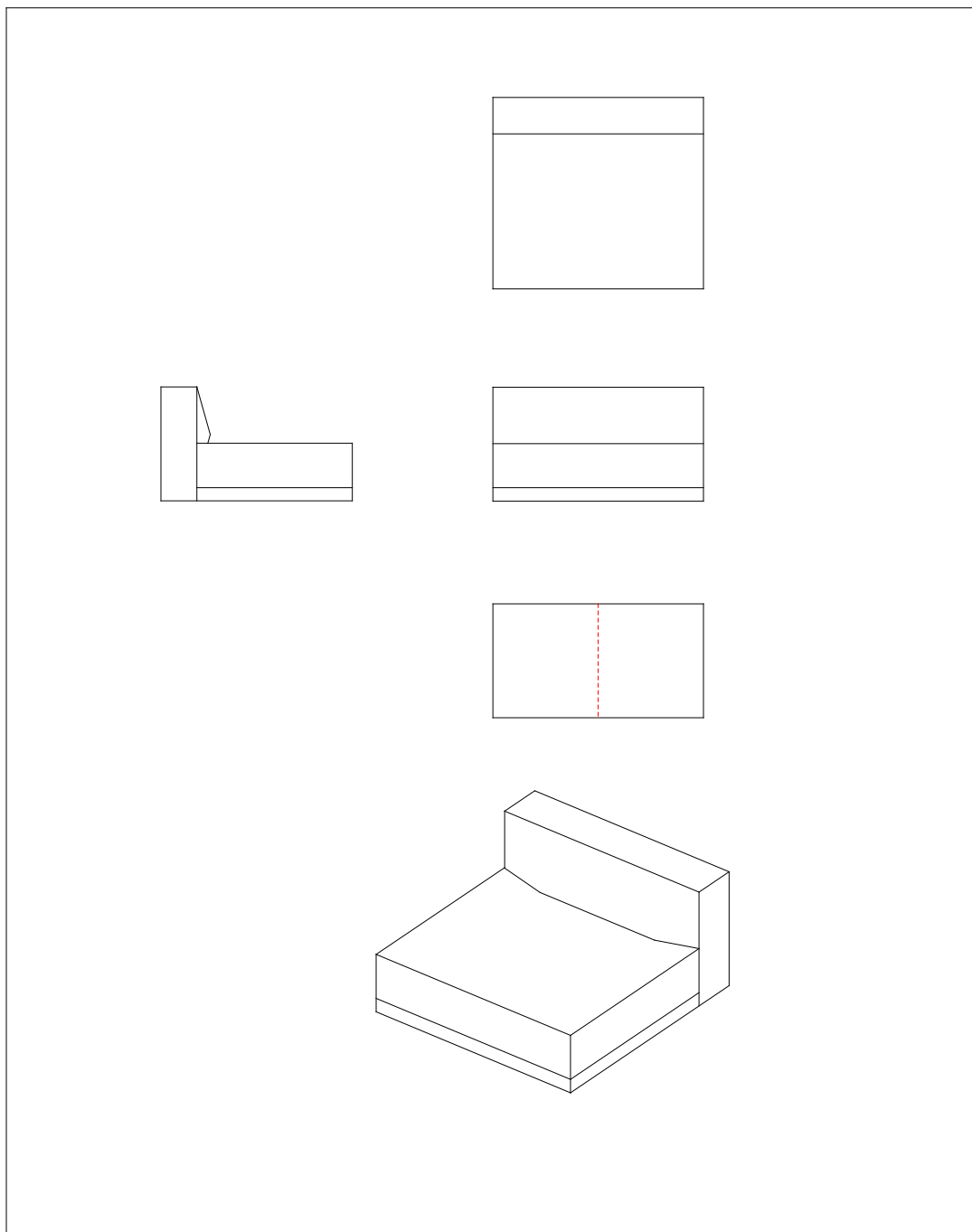

Stitching: Model RIG, center section,
120 x 100 cm in leather, #301-120

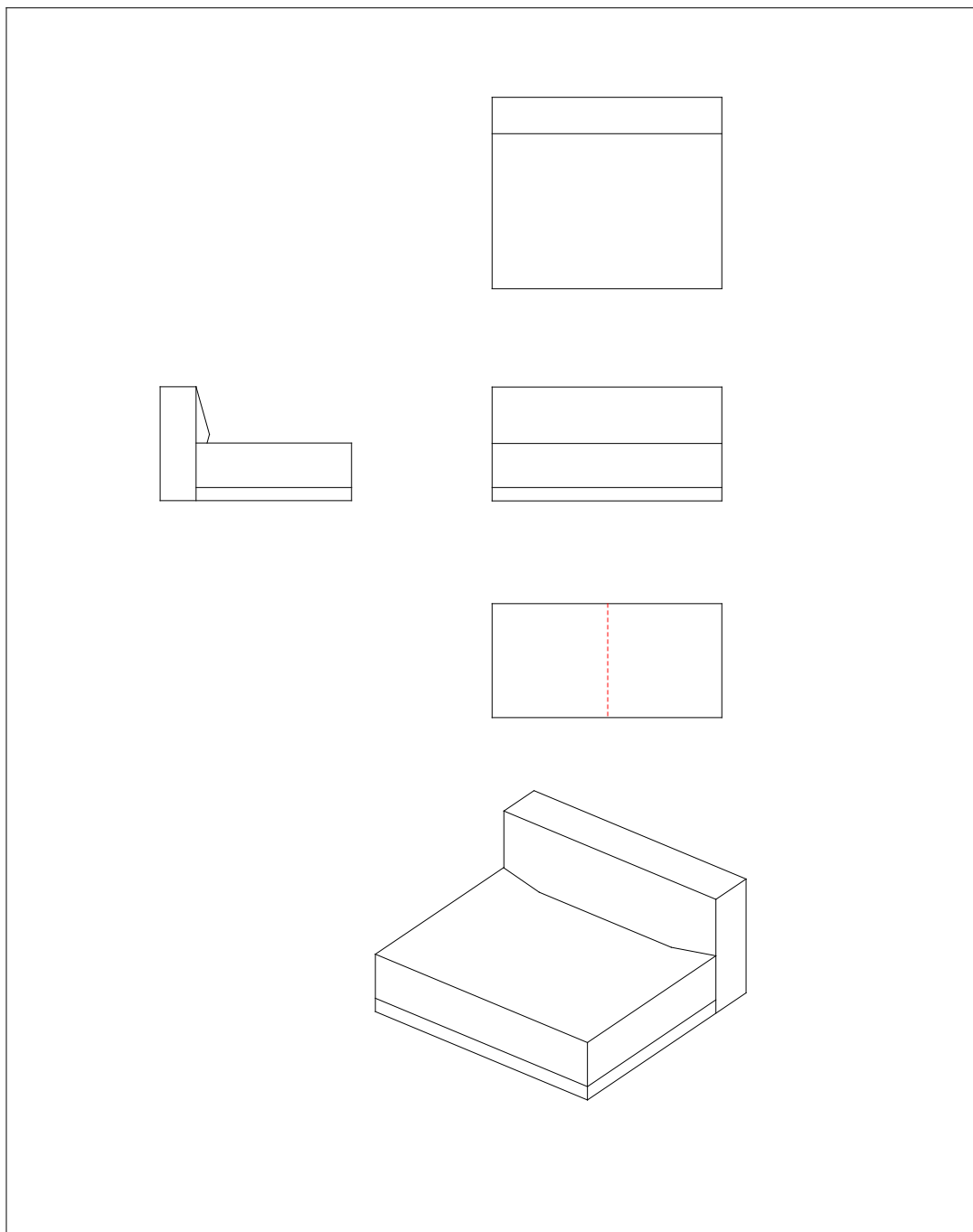

Stitching: Model RIG, center section,
130 x 100 cm in leather, #301-130

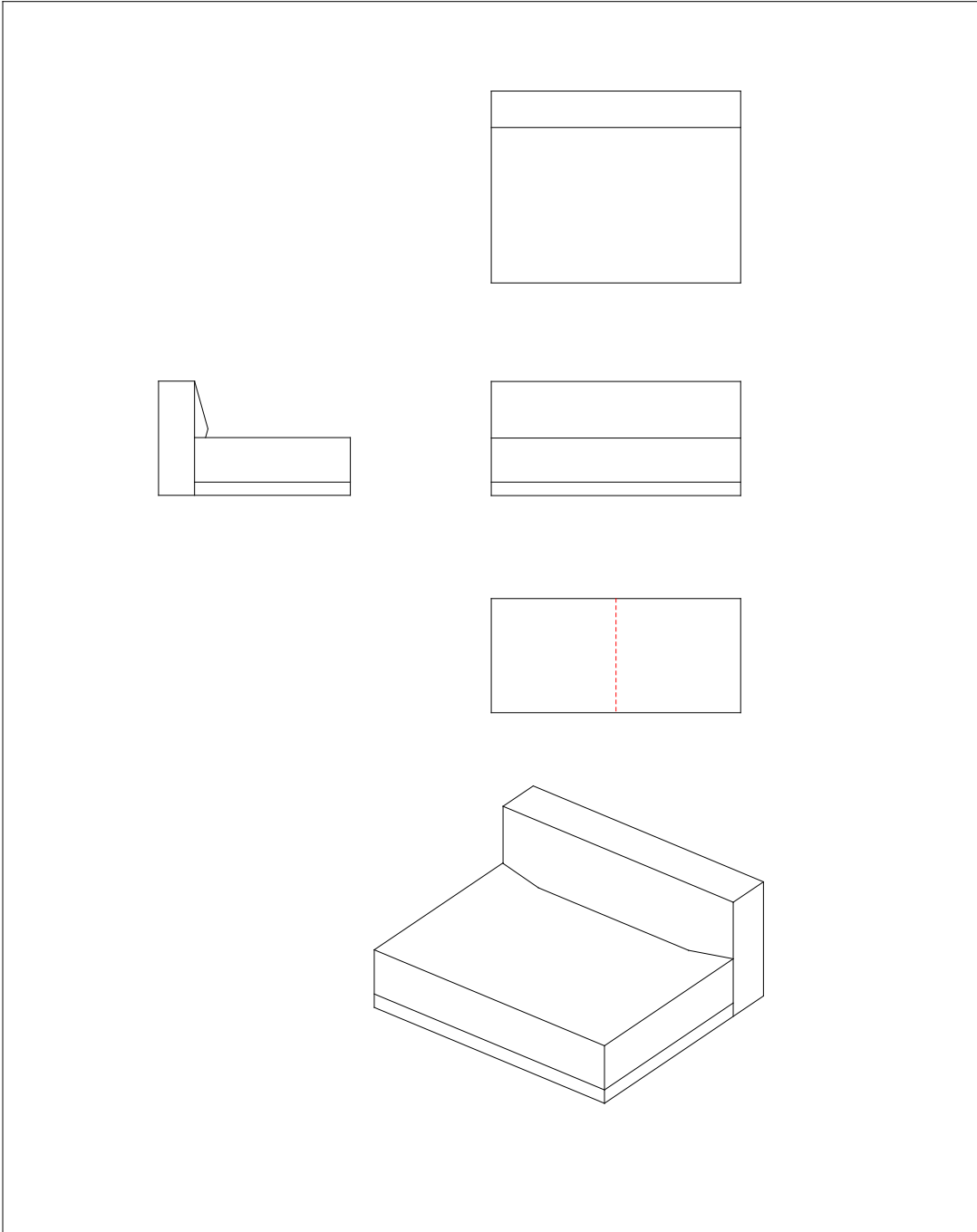

Stitching: Model RIG, center section,
140 x 100 cm in leather, #301-140

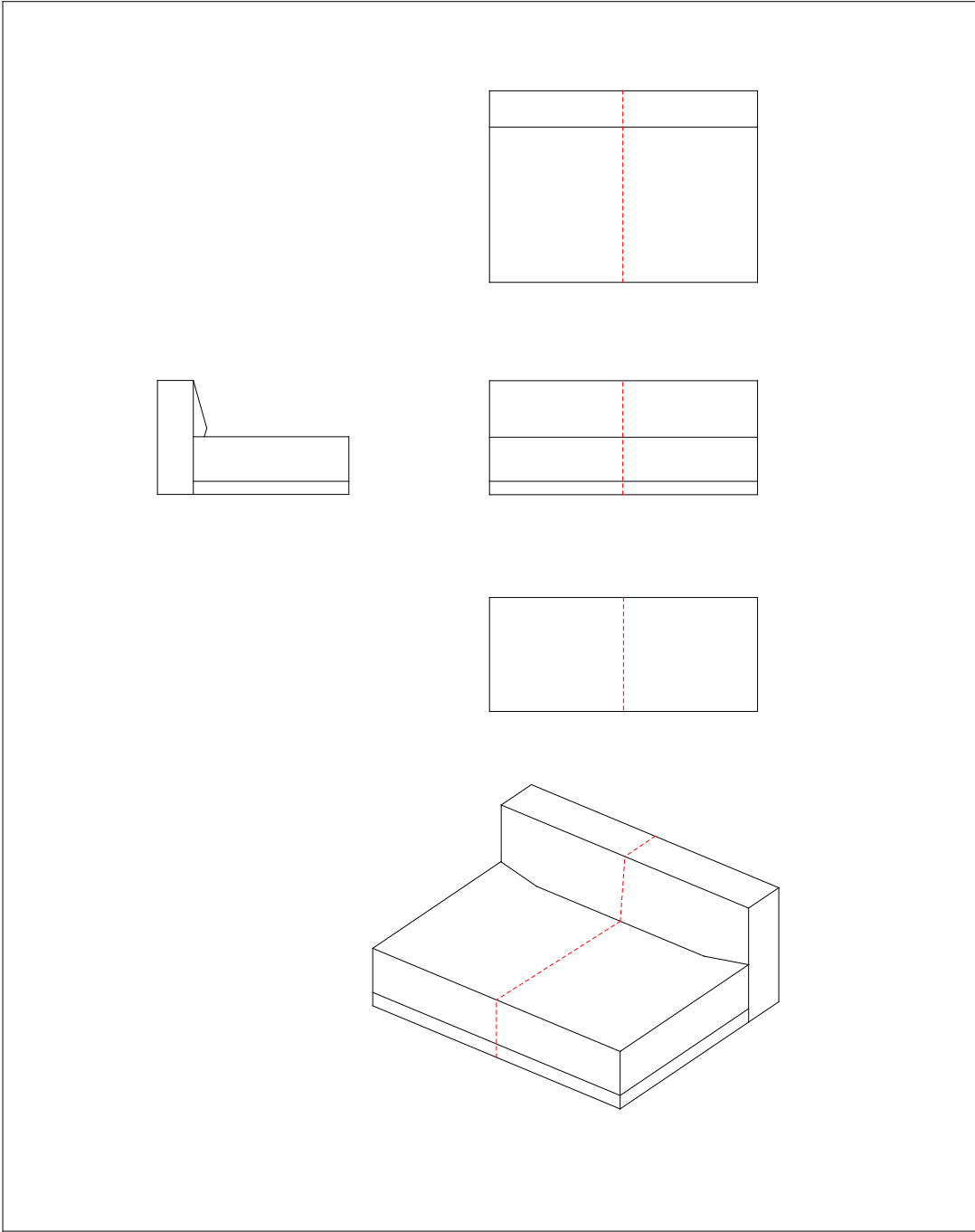

Stitching: Model RIG, center section,
150 x 100 cm in leather, #301-150

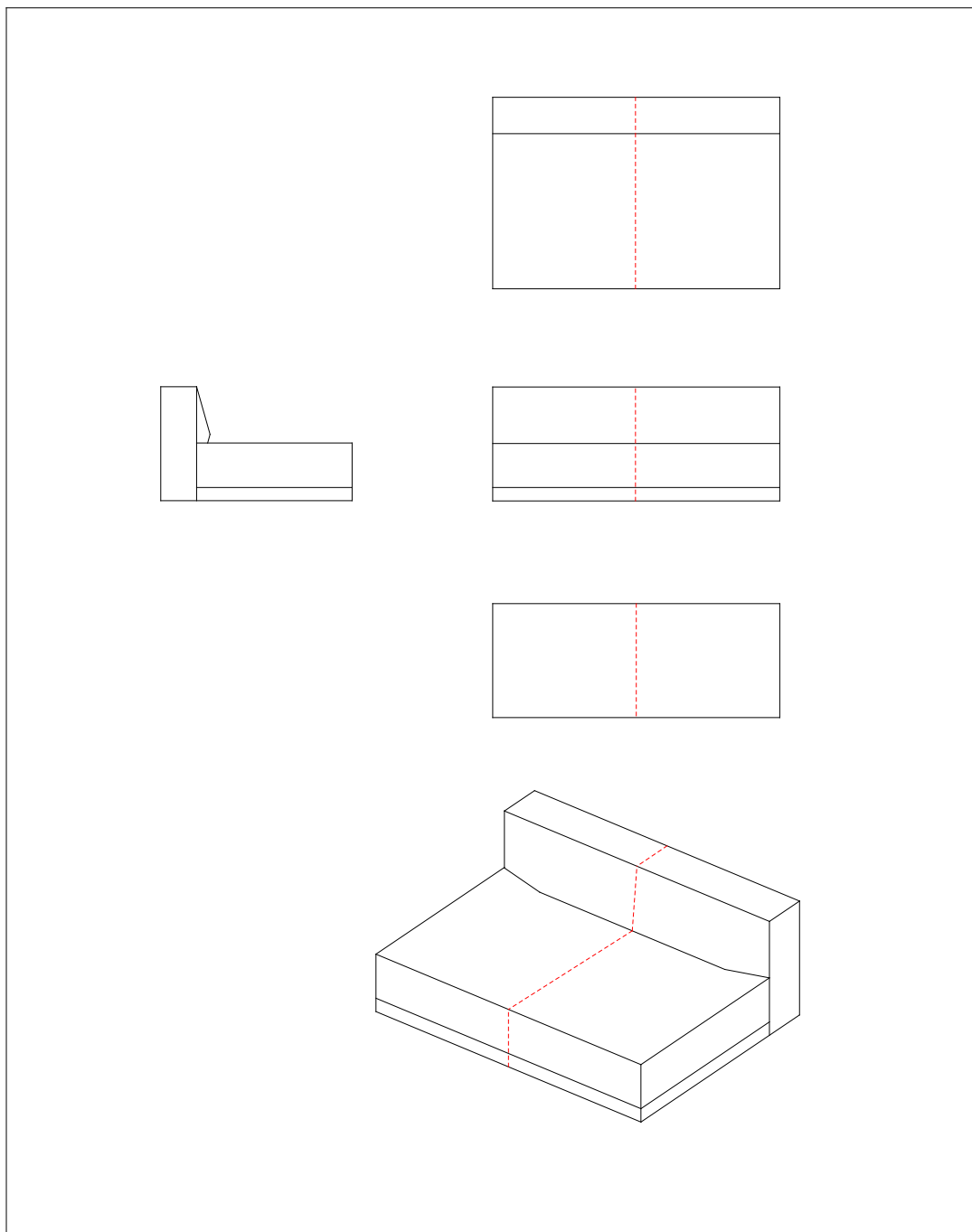

Stitching: Model RIG, center section,
160 x 100 cm in leather, #301-160

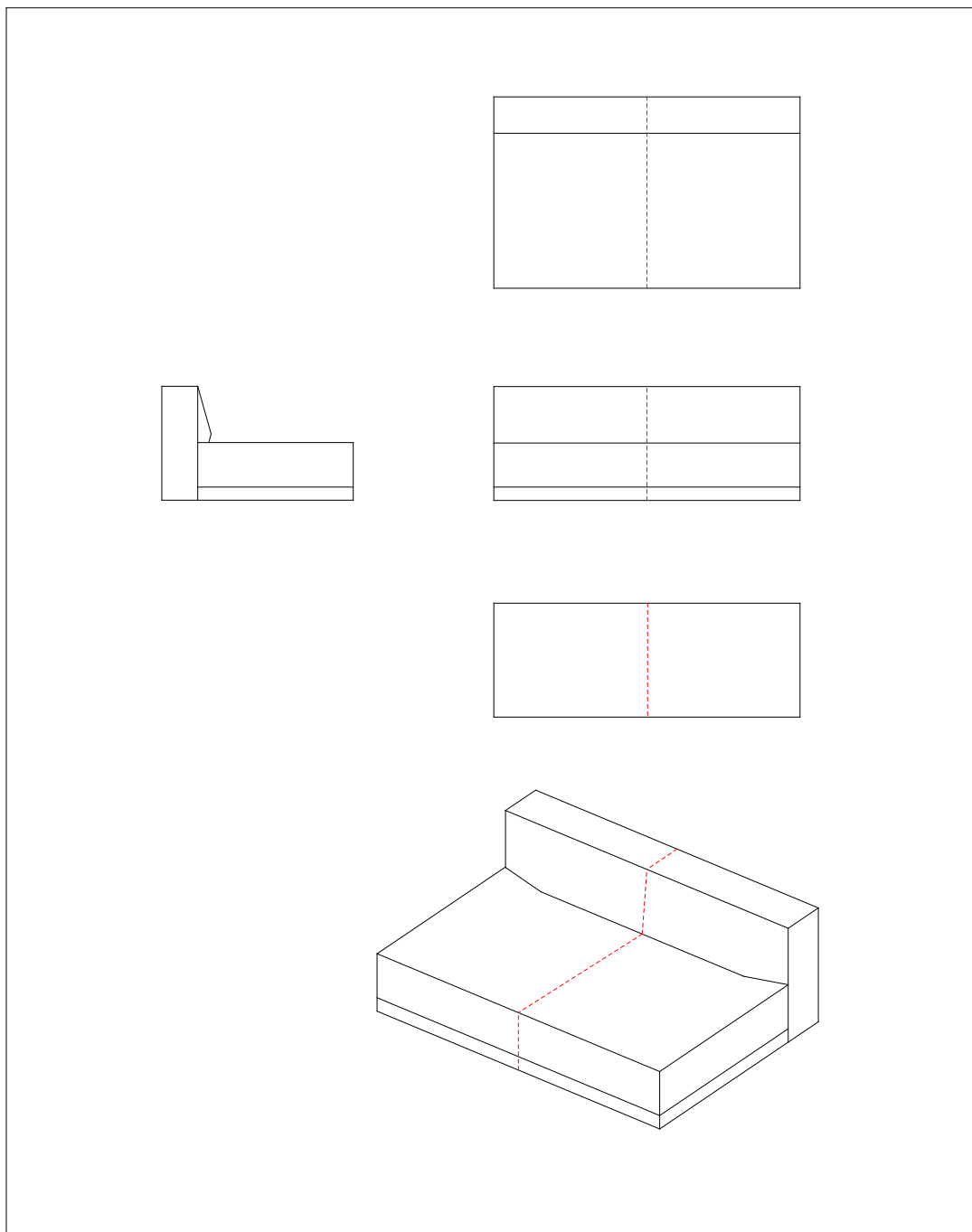

Stitching: Model RIG, center section,
170 x 100 cm in leather, #301-170

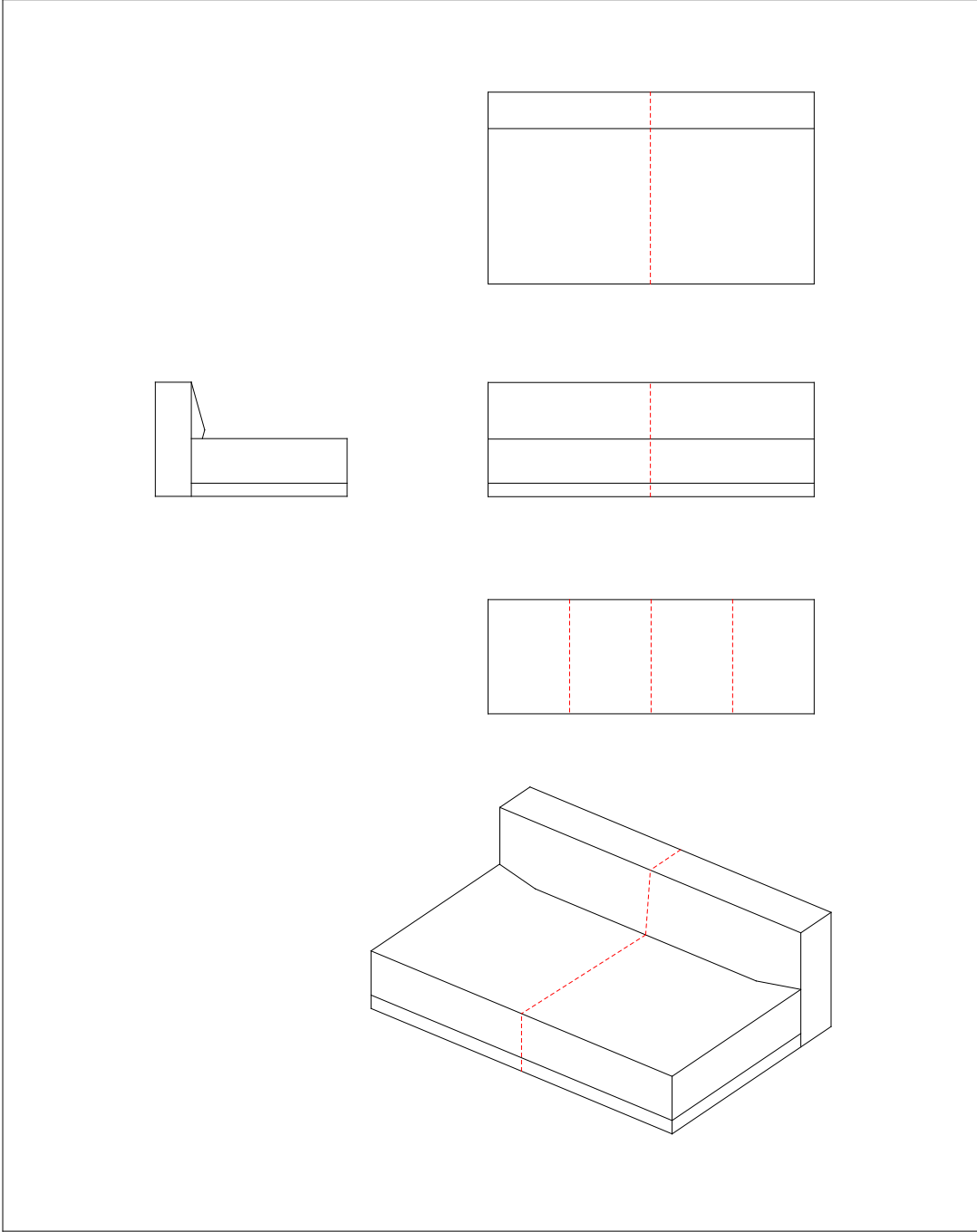

Stitching: Model RIG, center section,
180 x 100 cm in leather, #301-180

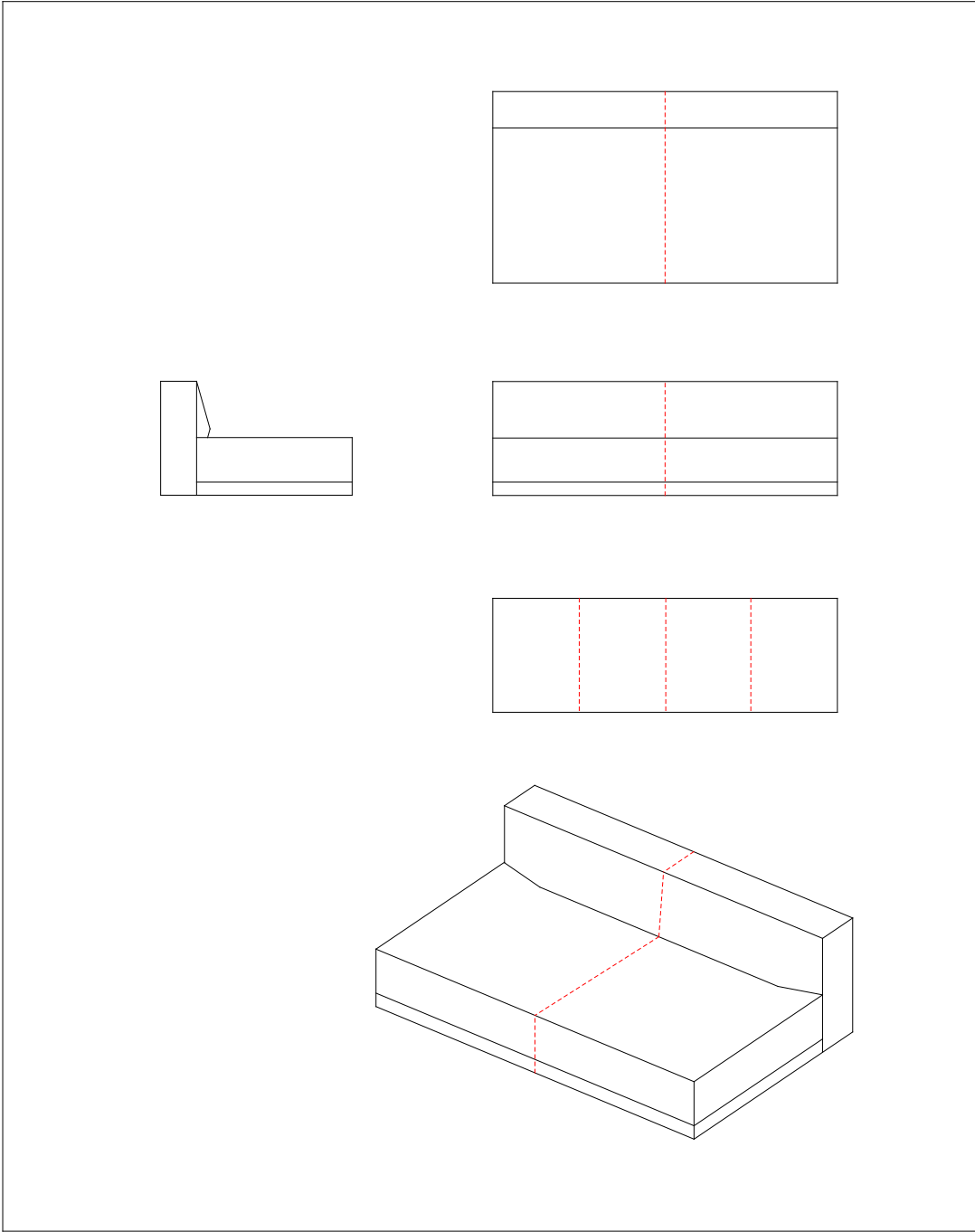

Stitching: Model RIG, center section,
190 x 100 cm in leather, #301-190

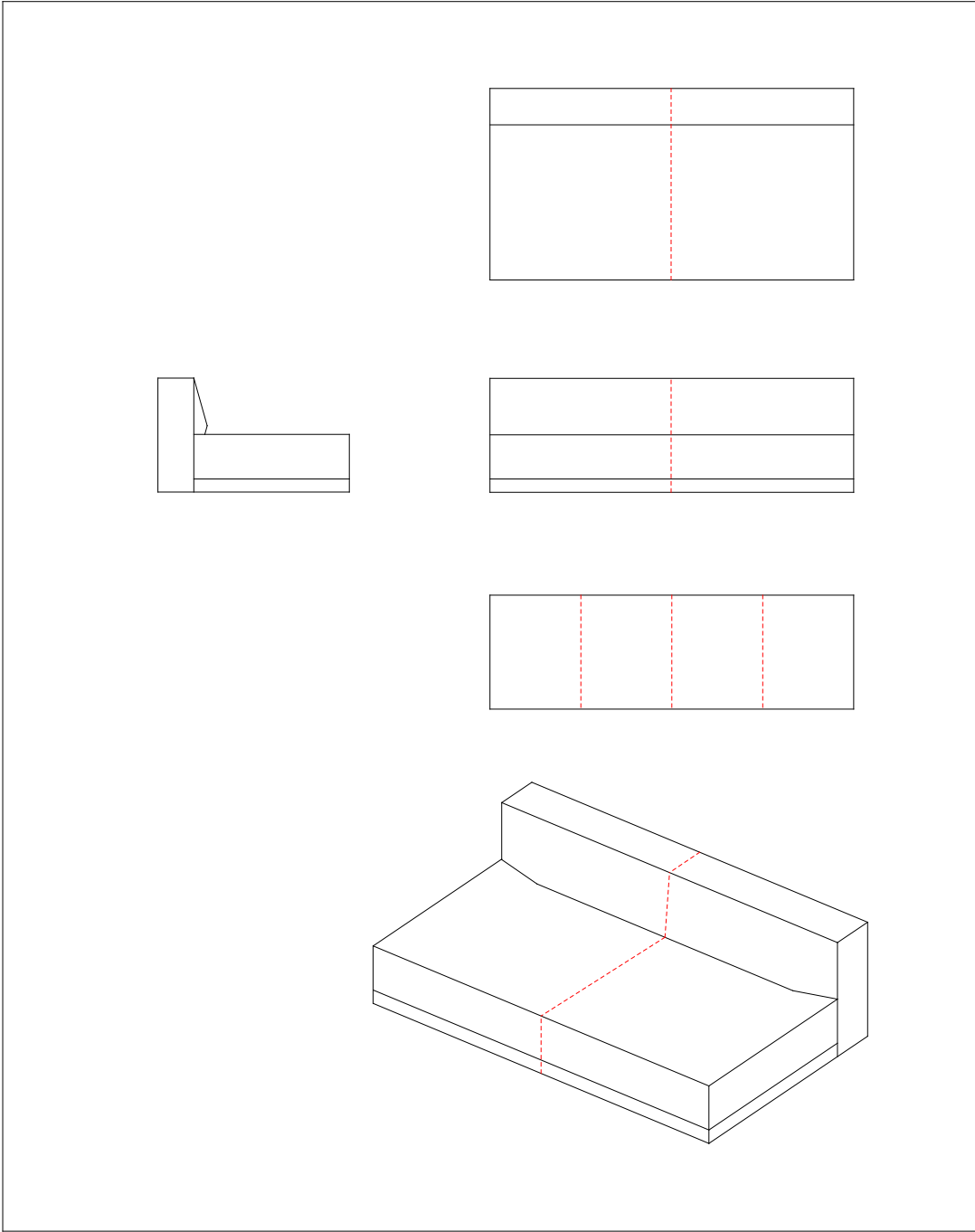

Stitching: Model RIG, center section,
200 x 100 cm in leather, #301-200

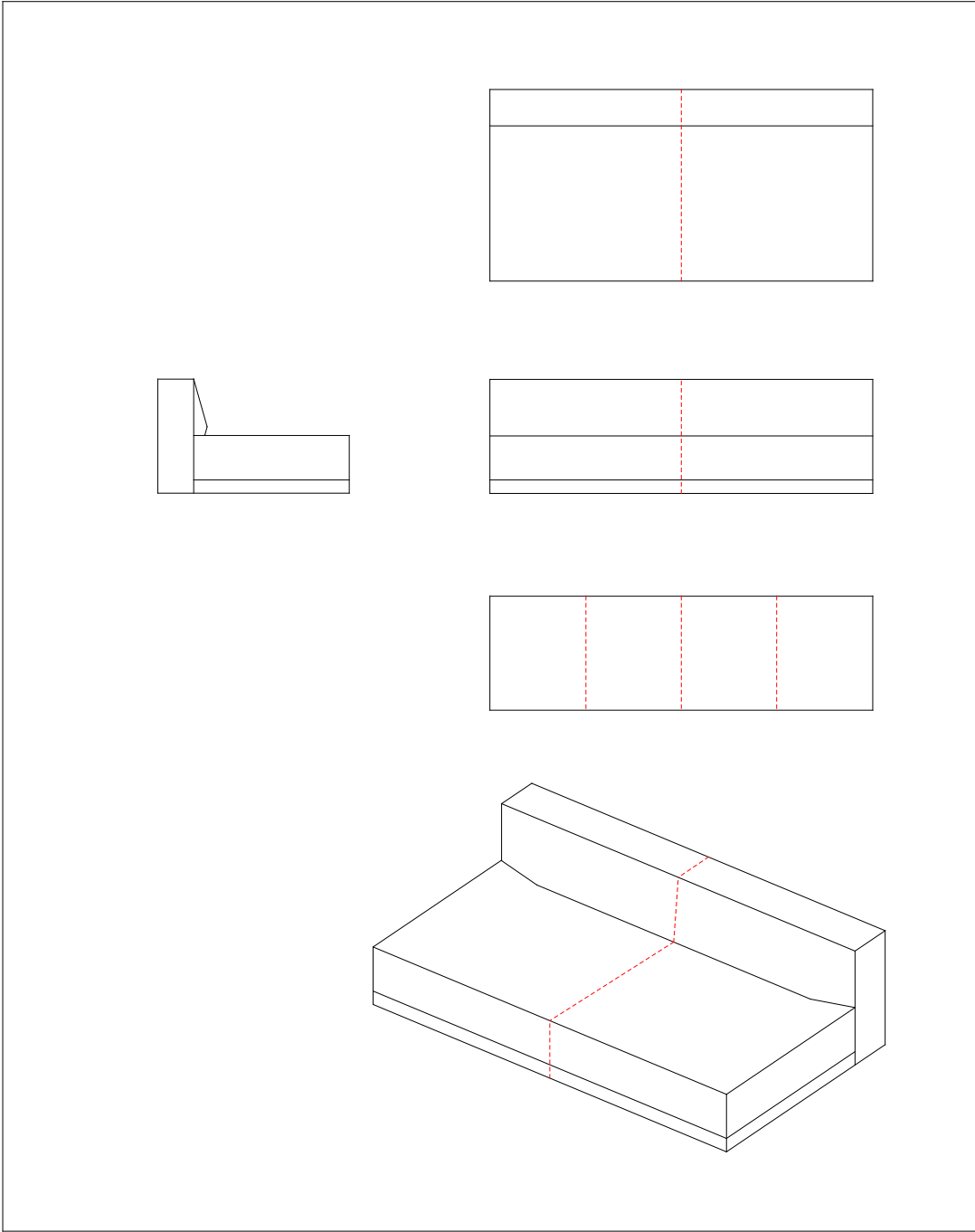

Stitching: Model RIG, center section,
210 x 100 cm in leather, #301-210

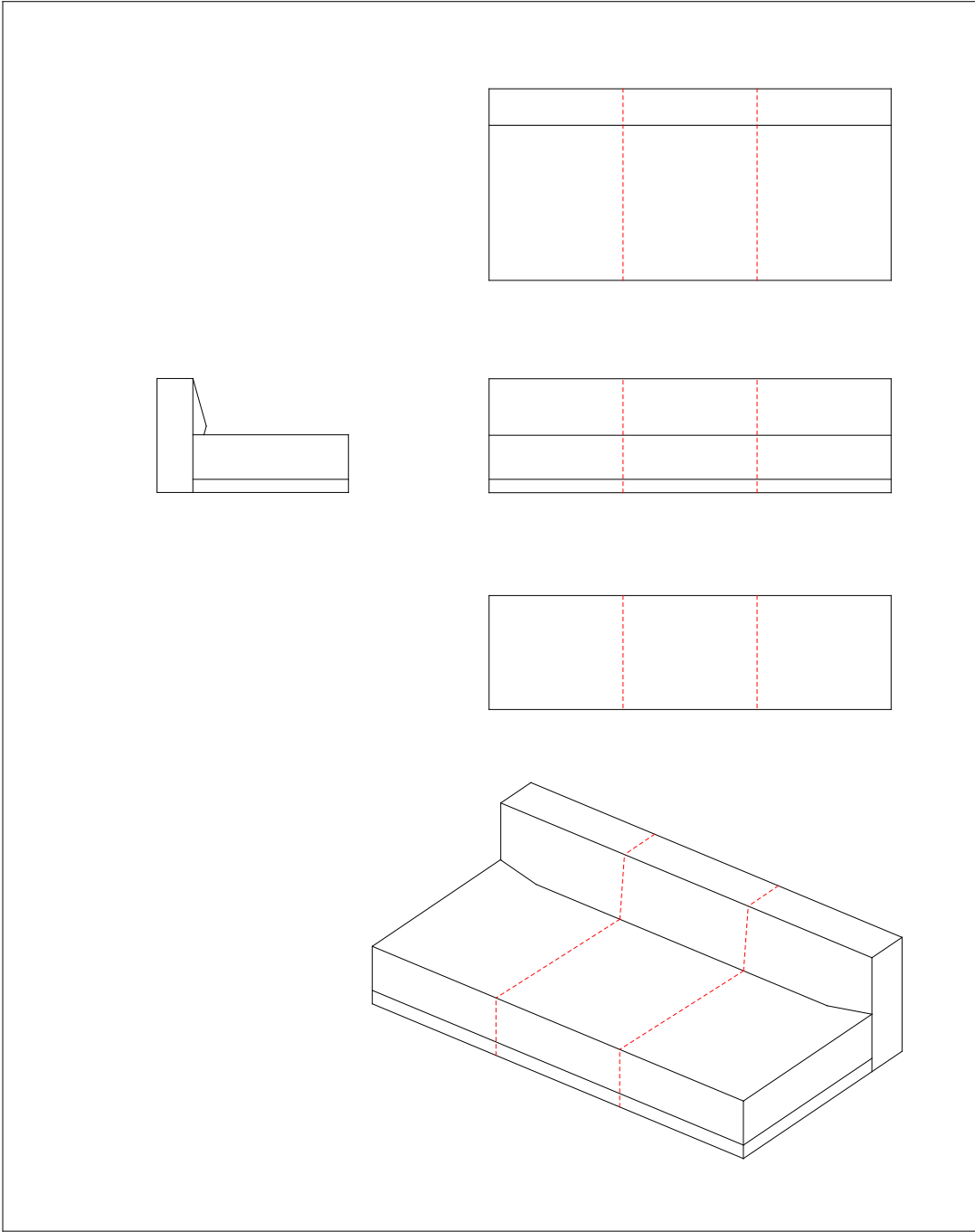

Stitching: Model RIG, center section,
220 x 100 cm in leather, #301-220

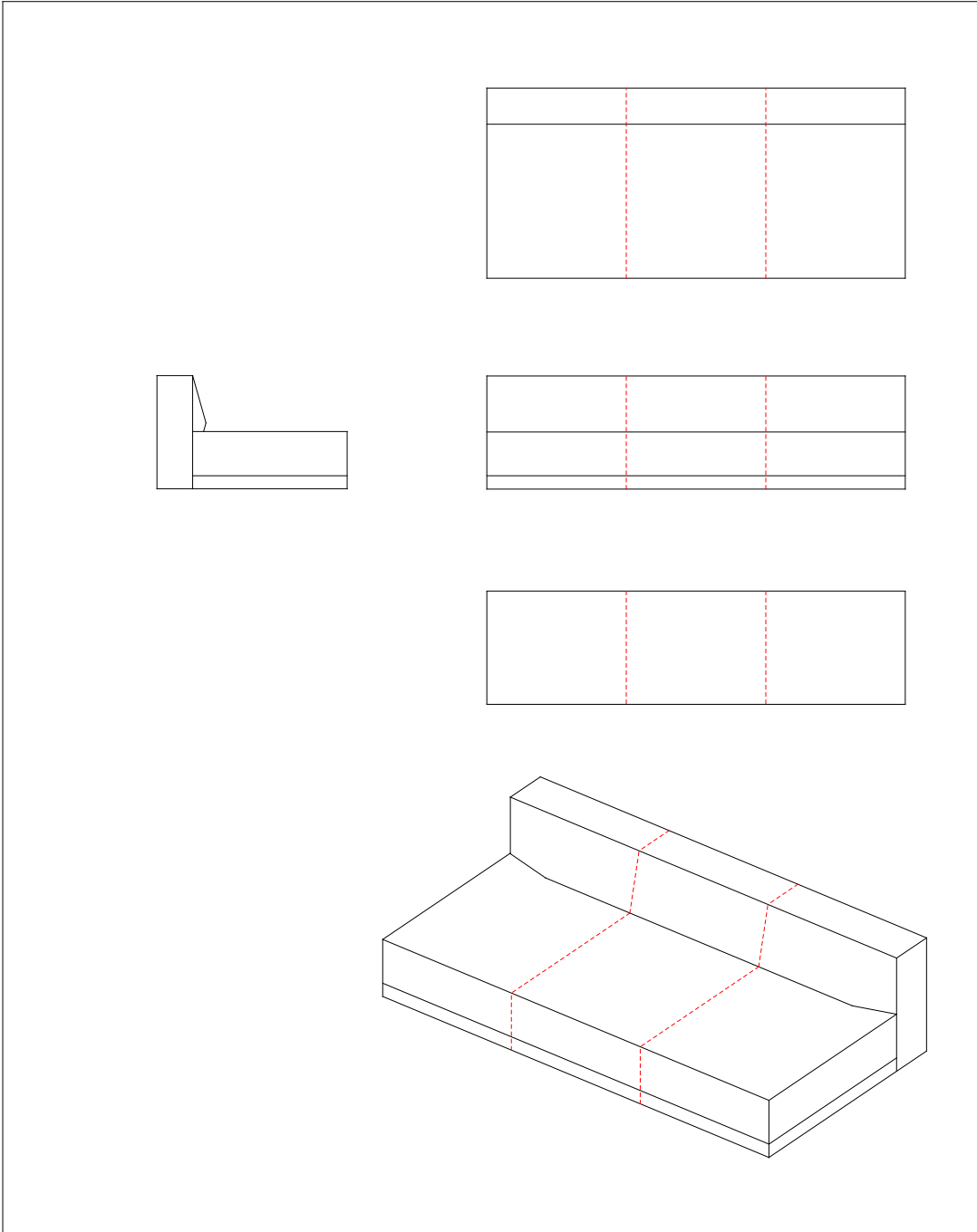

Stitching: Model RIG, closing section, right and left,
120 x 100 cm in leather, #302-120 / #303-120

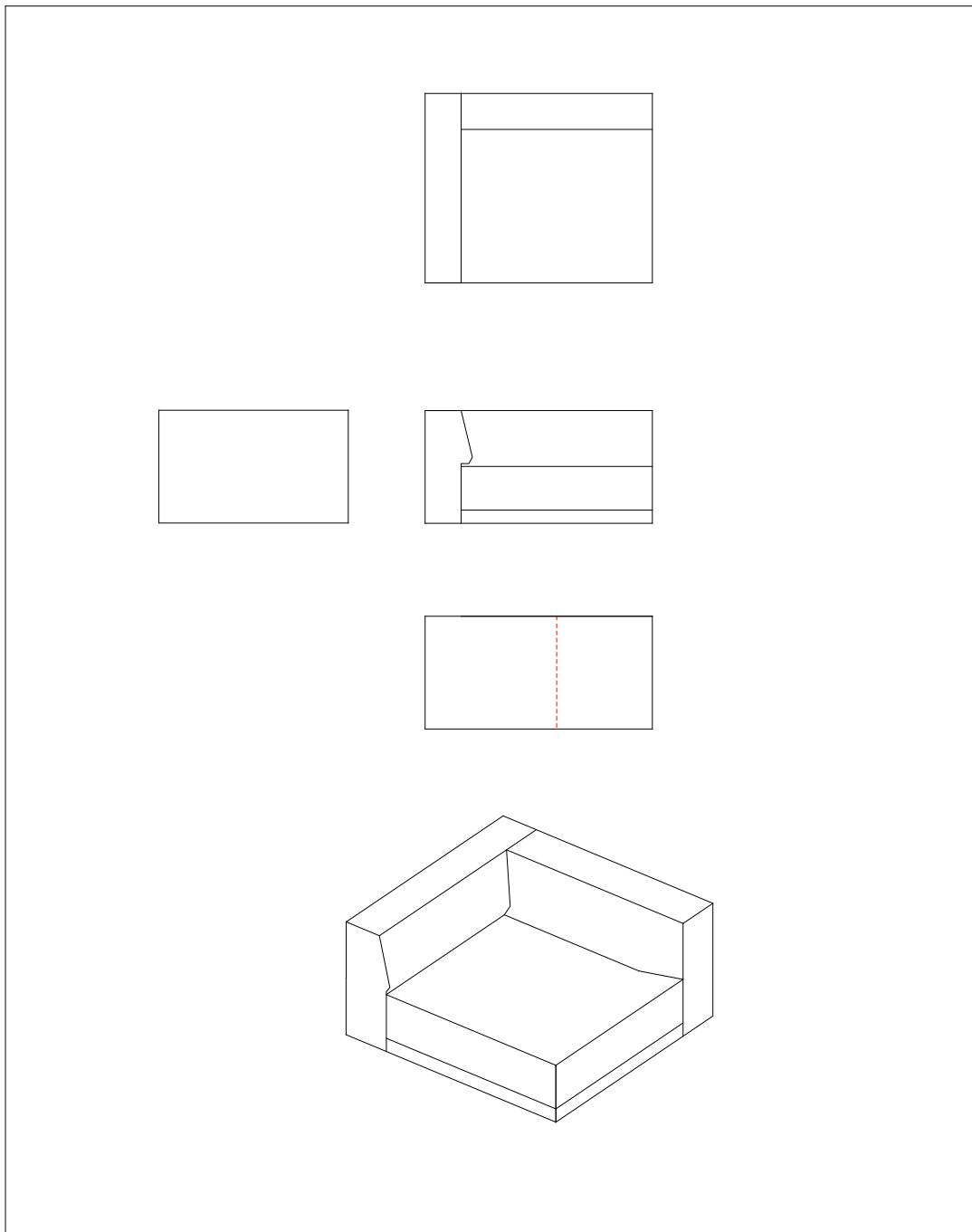

Stitching: Model RIG, closing section, right and left,
130 x 100 cm in leather, #302-130 / #303-130

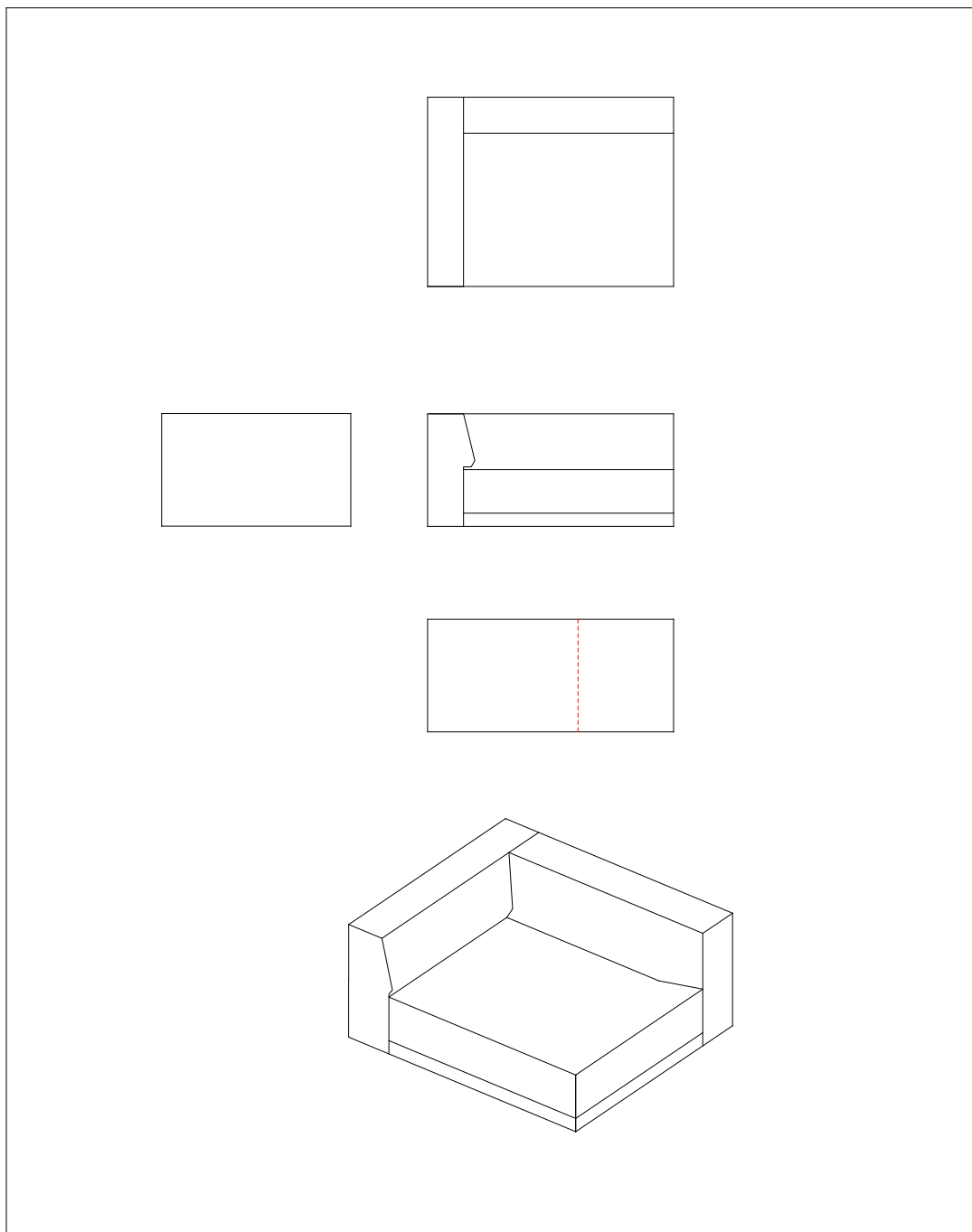

Stitching: Model RIG, closing section, right and left,
140 x 100 cm in leather, #302-140 / #303-140

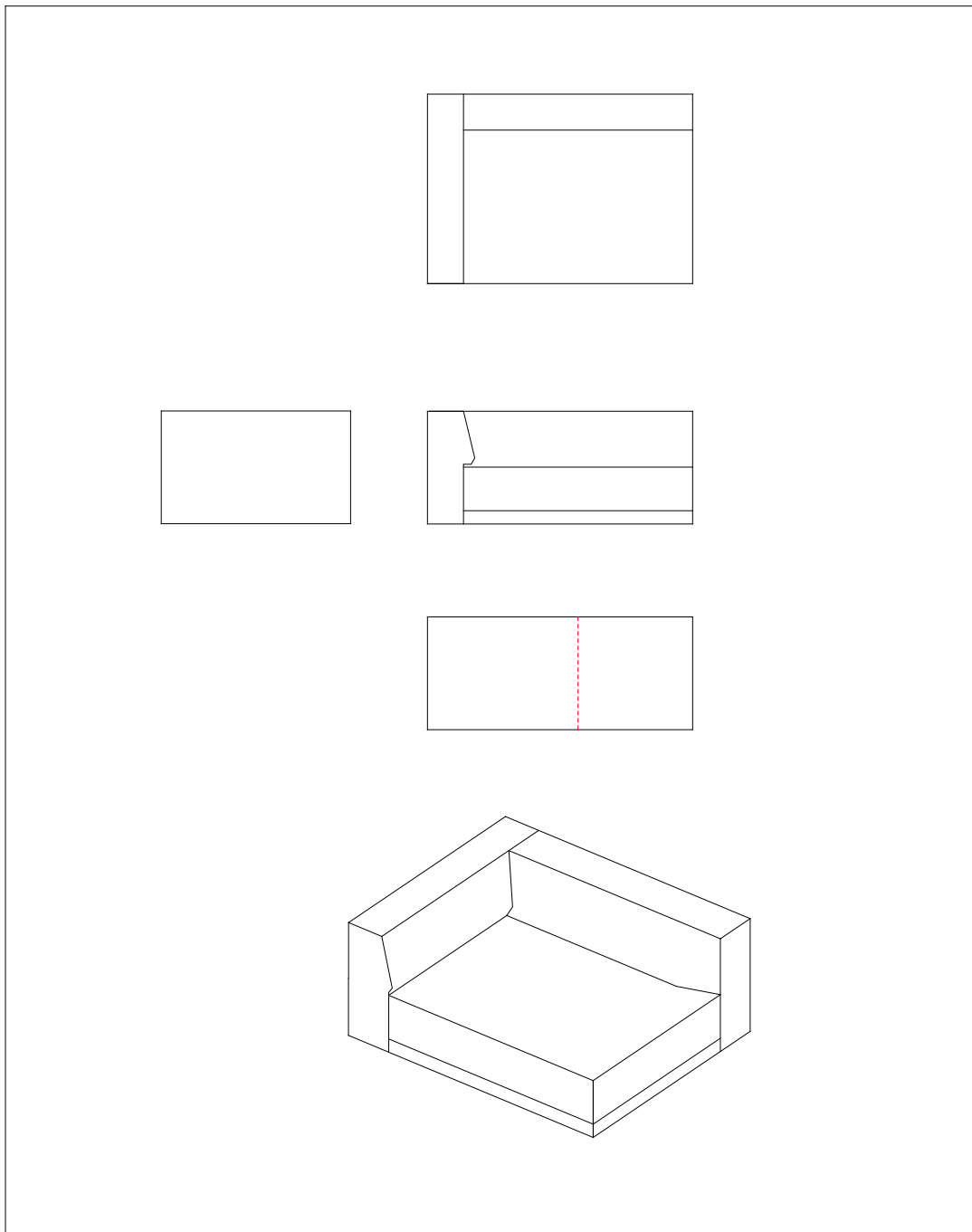

Stitching: Model RIG, closing section, right and left,
150 x 100 cm in leather, #302-150 / #303-150

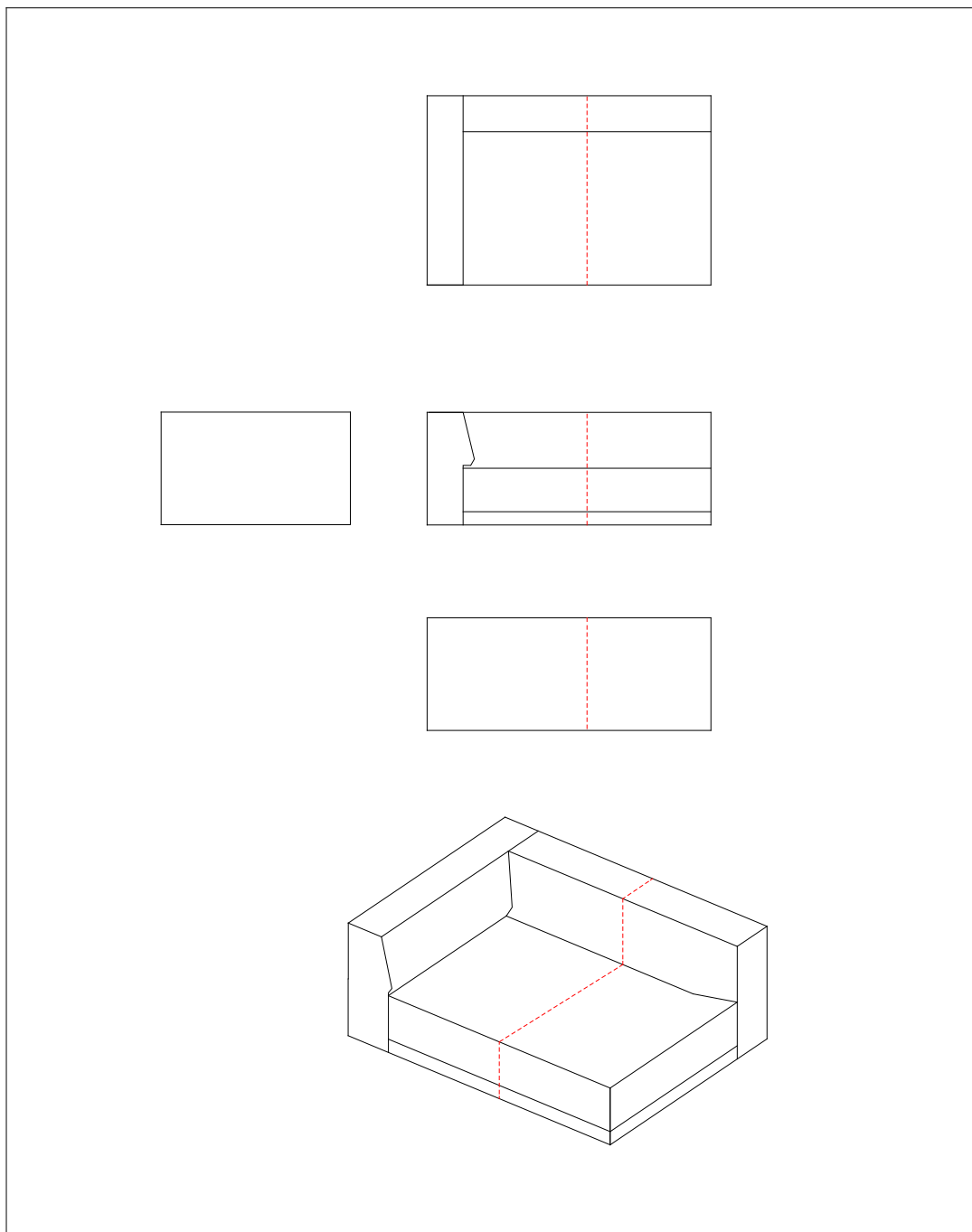

Stitching: Model RIG, closing section, right and left,
160 x 100 cm in leather, #302-160 / #303-160

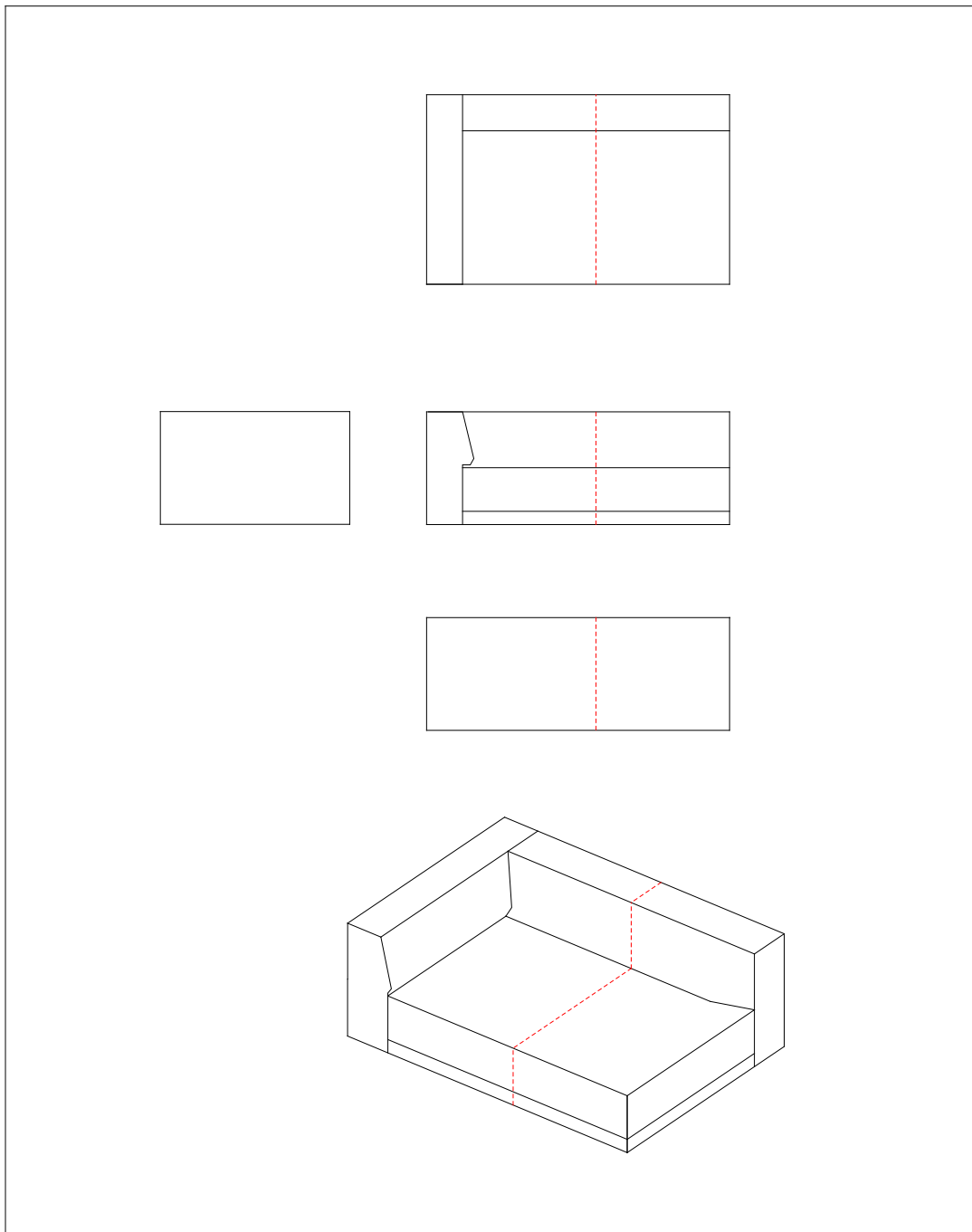

Stitching: Model RIG, closing section, right and left,
170 x 100 cm in leather, #302-170 / #303-170

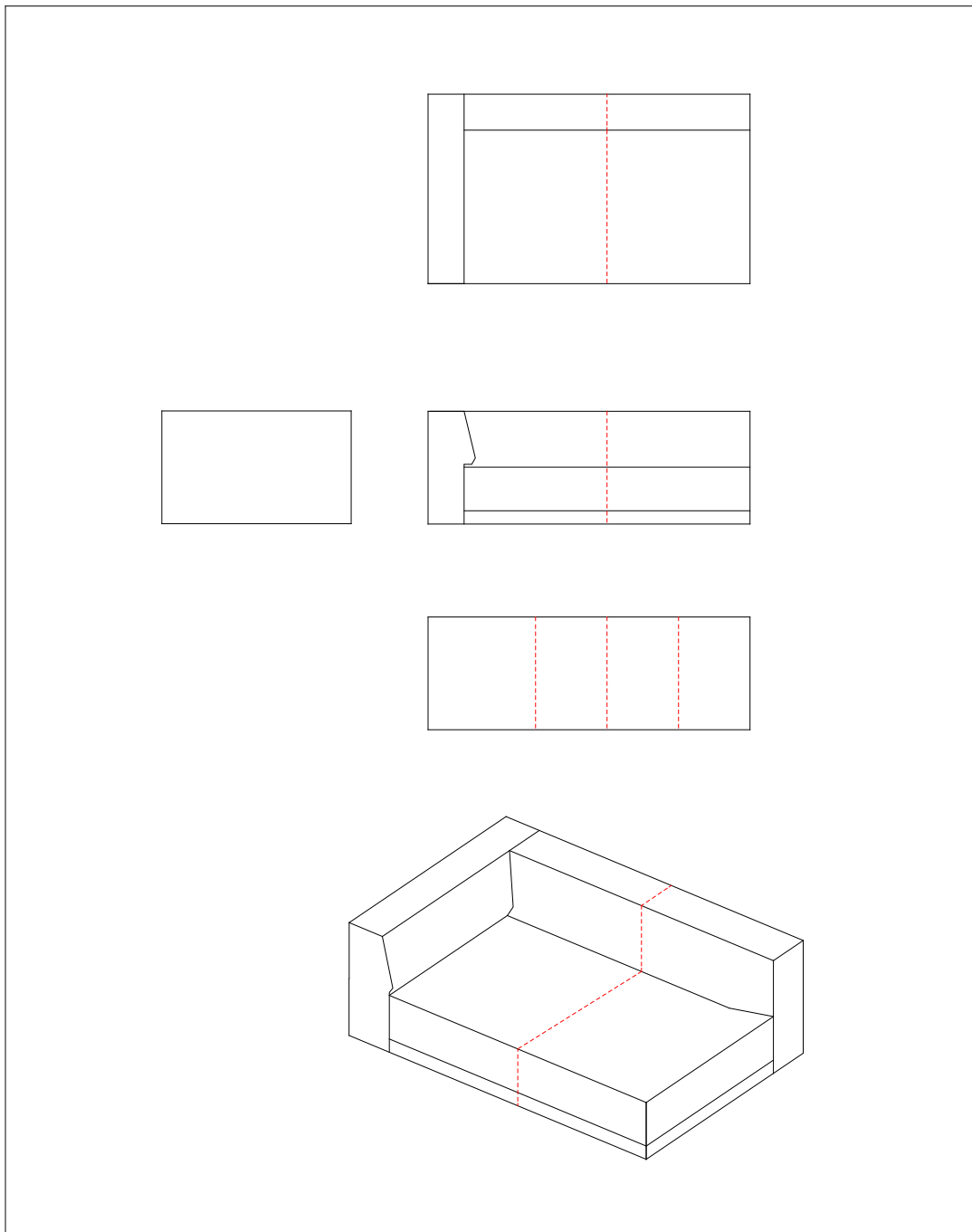

Stitching: Model RIG, closing section, right and left,
180 x 100 cm in leather, #302-180 / #303-180

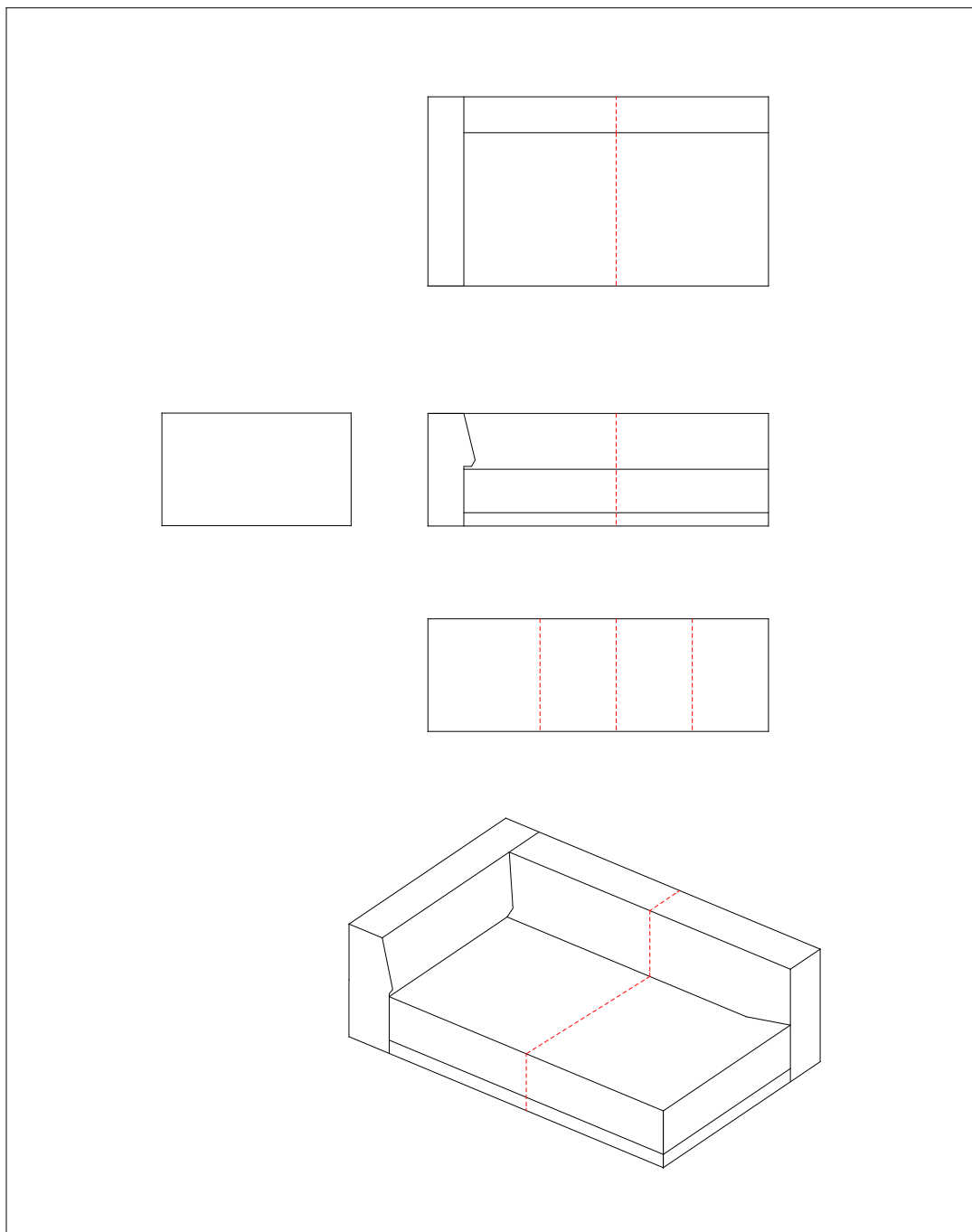

Stitching: Model RIG, closing section, right and left,
190 x 100 cm in leather, #302-190 / #303-190

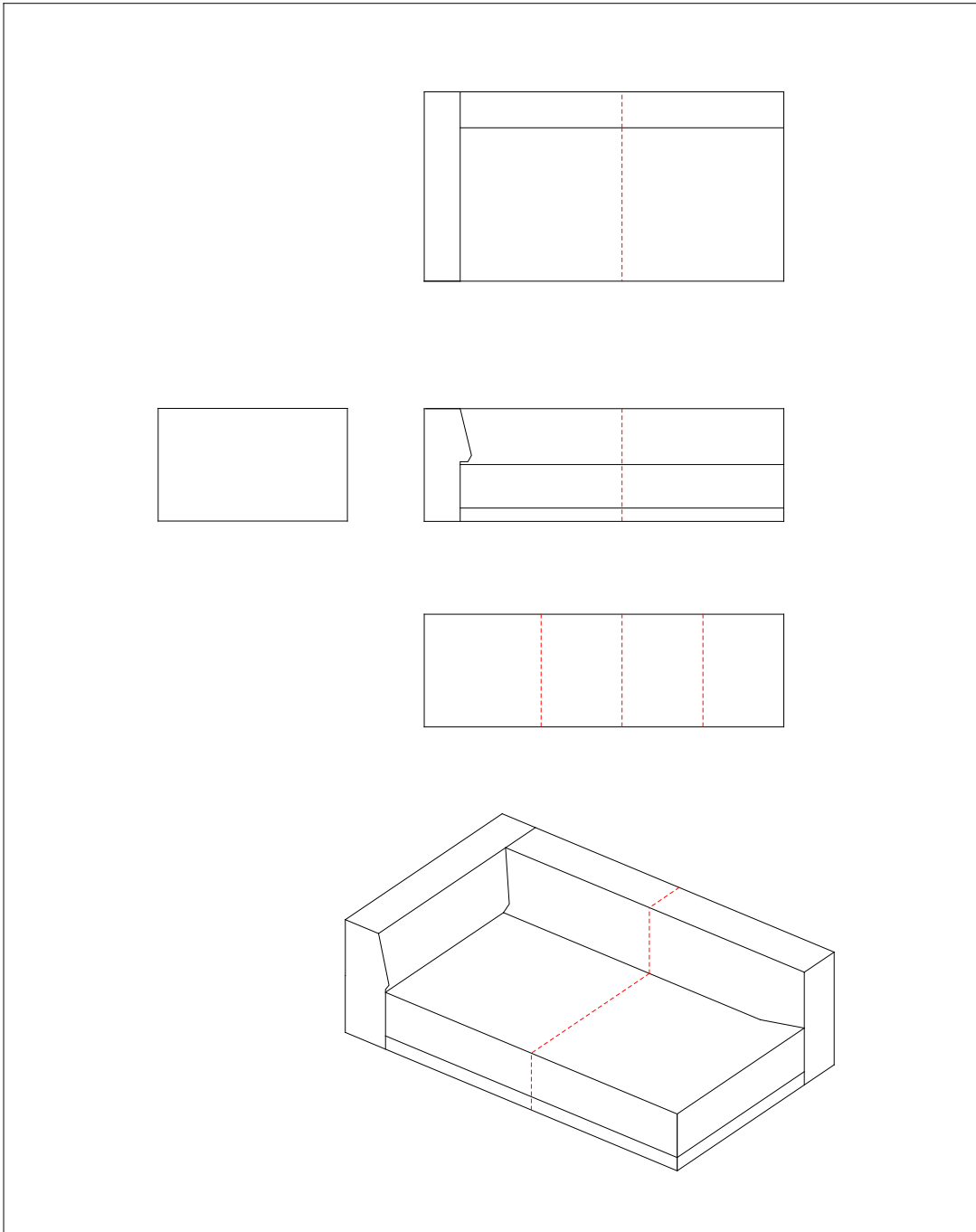

Stitching: Model RIG, closing section, right and left,
200 x 100 cm in leather, #302-200 / #303-200

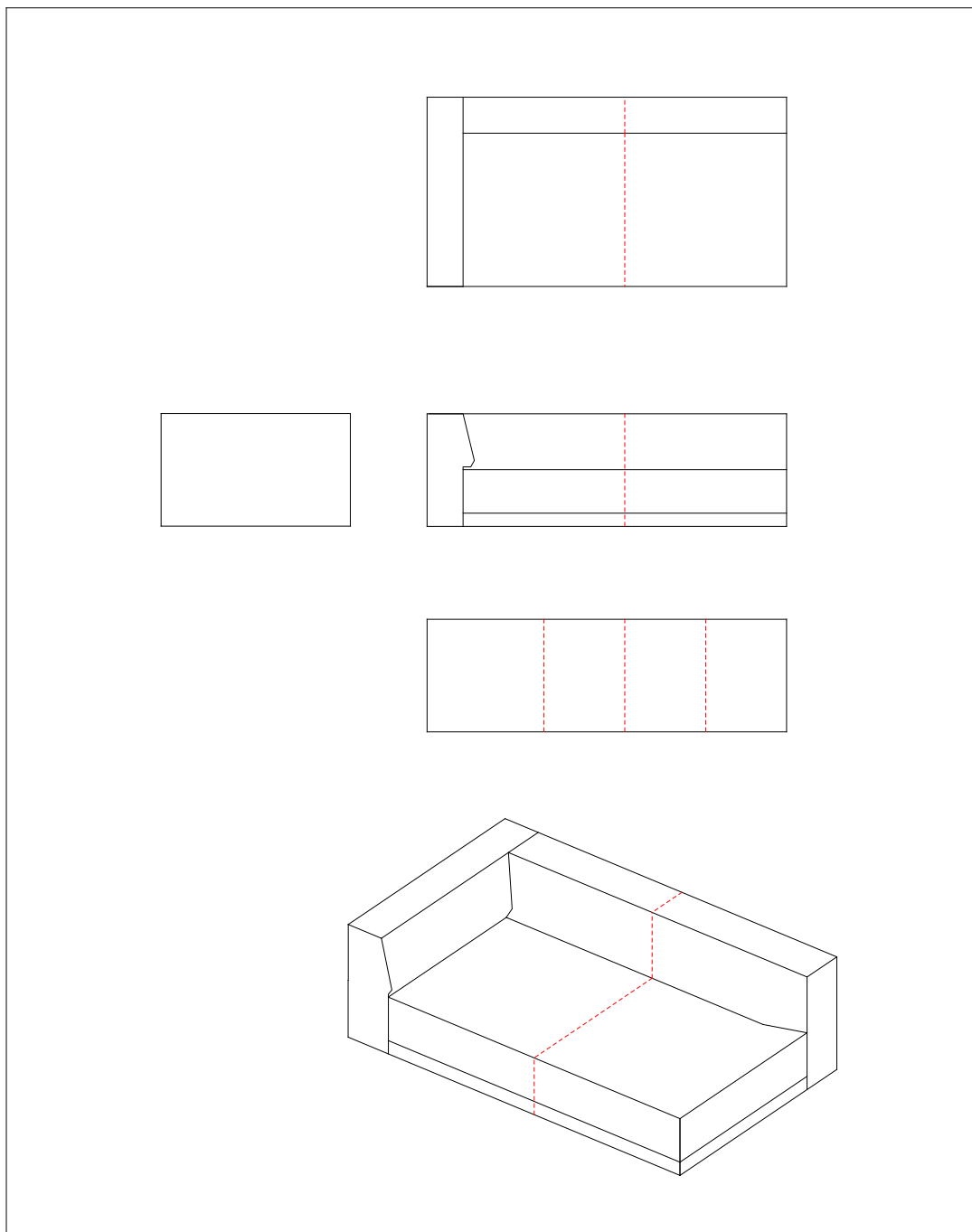

Stitching: Model RIG, closing section, right and left,
210 x 100 cm in leather, #302-210 / #303-210

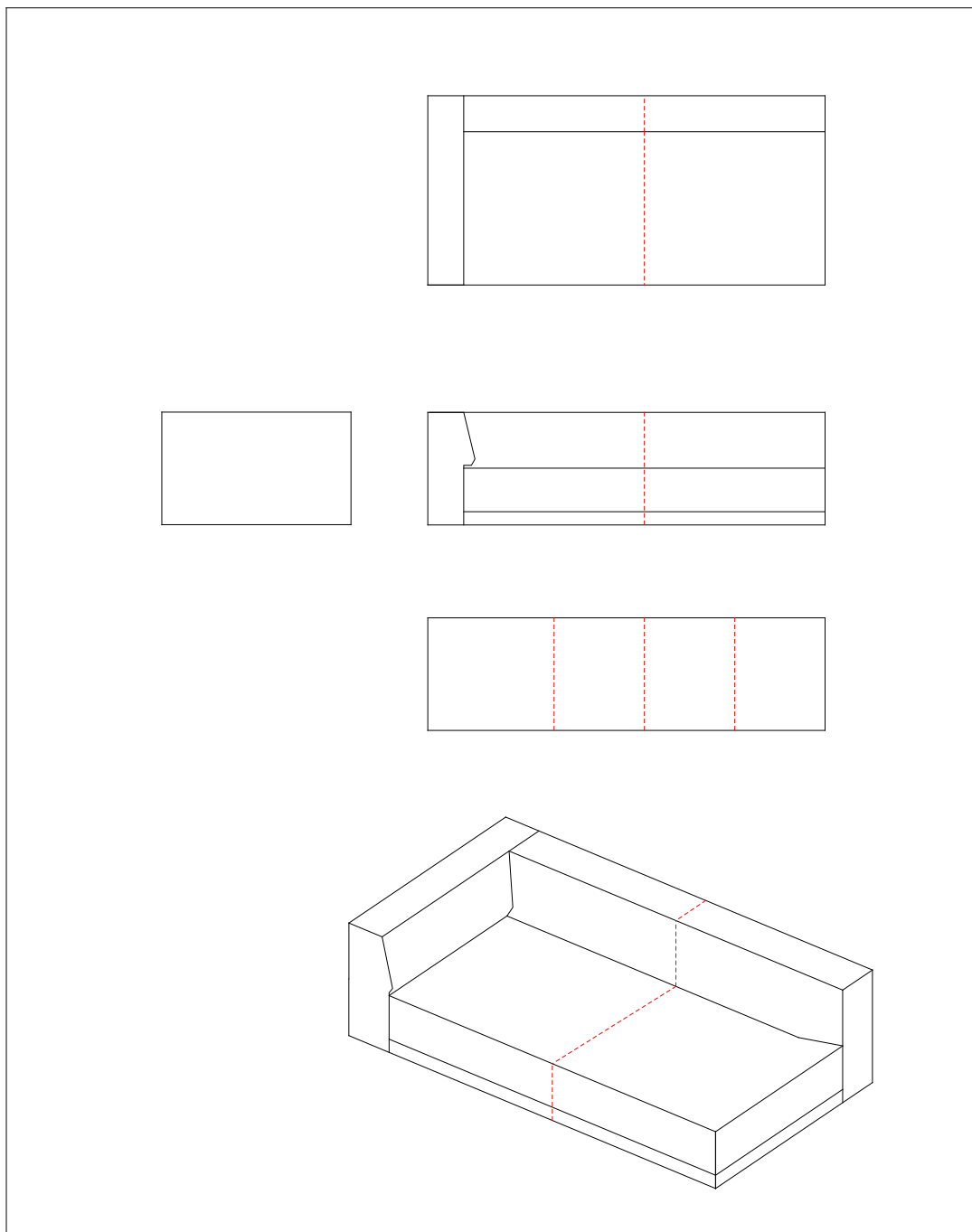

Stitching: Model RIG, closing section, right and left,
220 x 100 cm in leather, #302-220 / #303-220

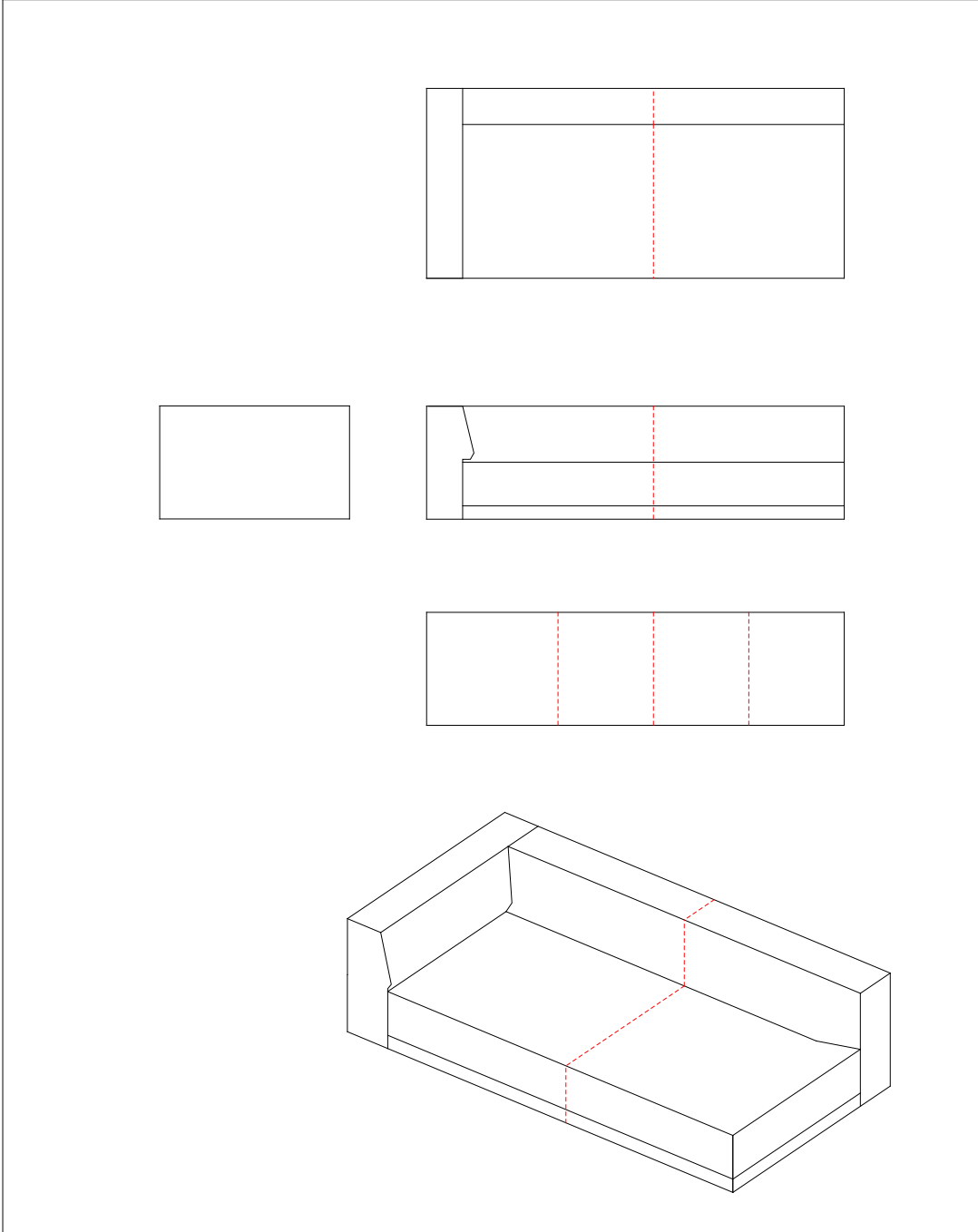

Stitching: Model RIG, center section with short back, right and left,
160 x 100 cm in leather, #312-160 / #313-160

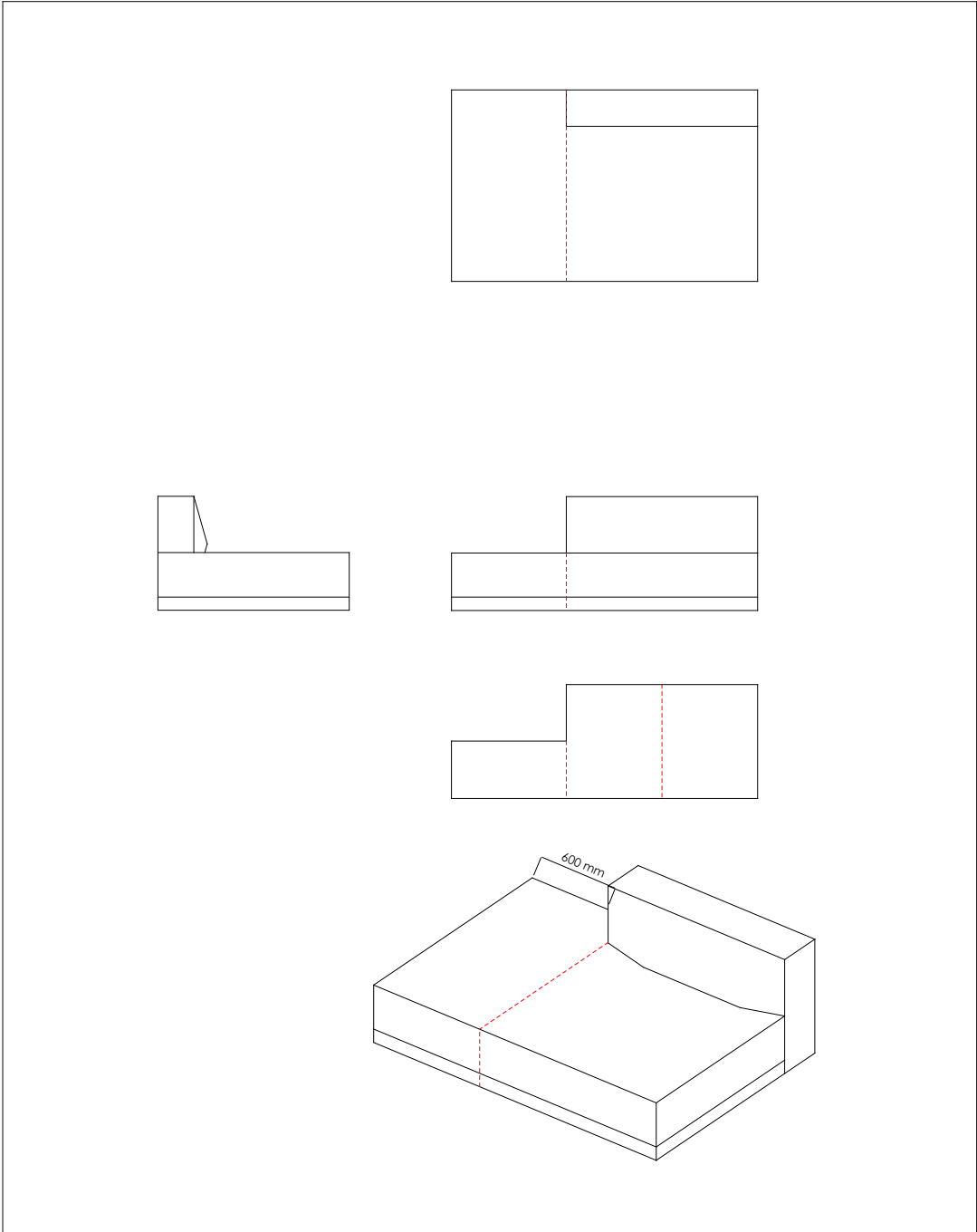

Stitching: Model RIG, center section with short back, right and left,
200 x 100 cm in leather, #312-200 / #313-200

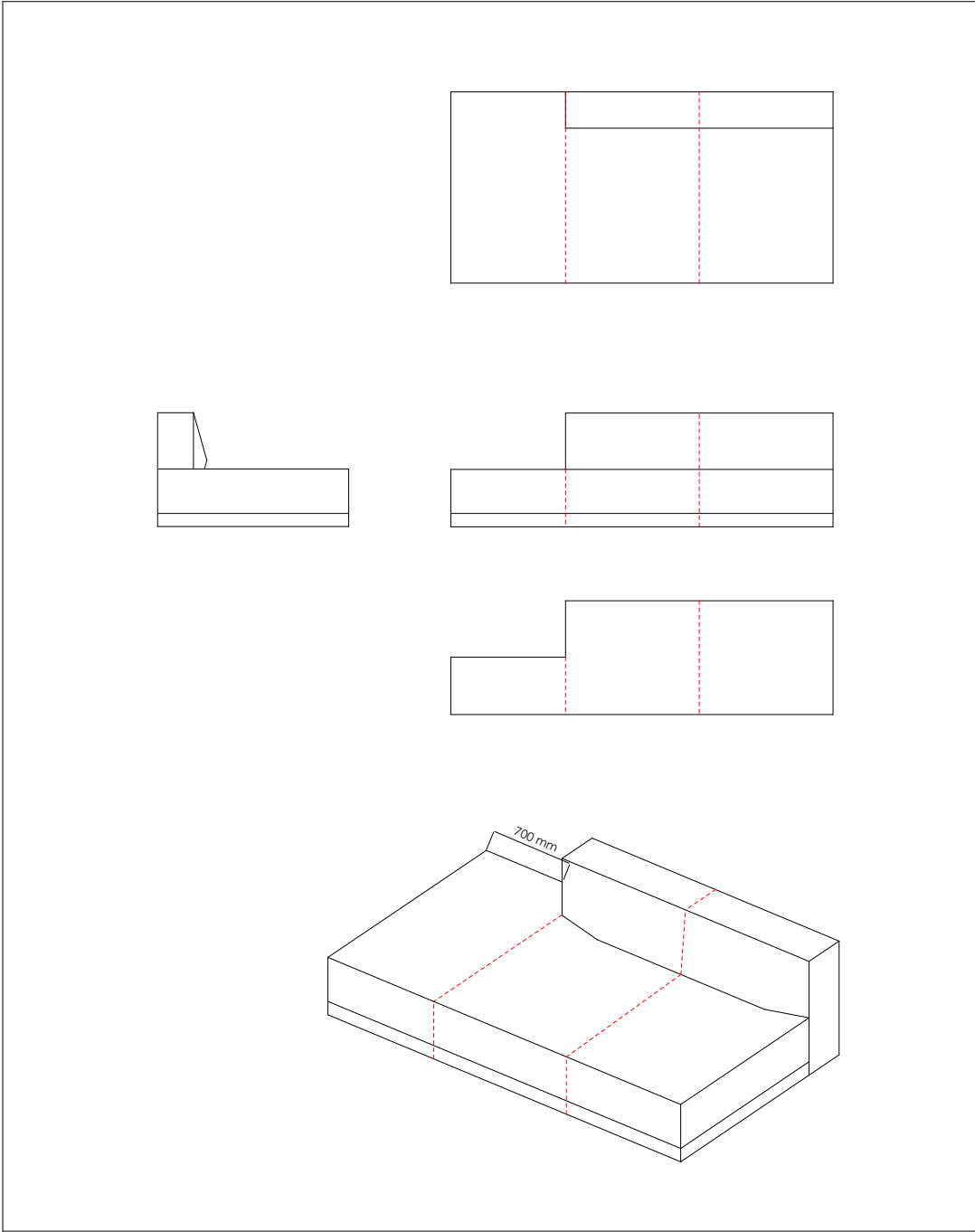

Stitching: Model RIG, chaiselong with arm, right and left,
110 x 170 cm in leather, #306-110 / #307-110

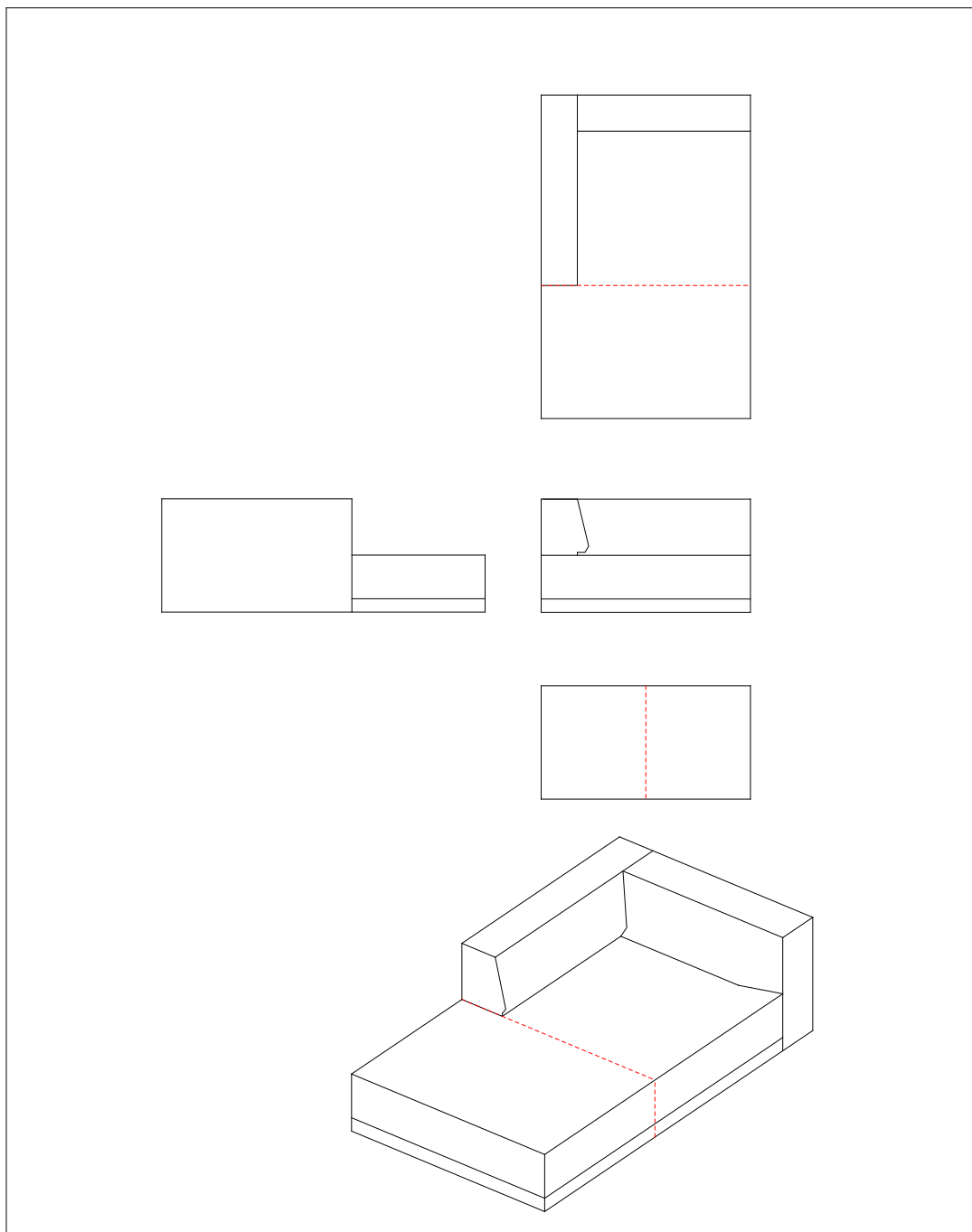

Stitching: Model RIG, chaiselong with arm, right and left,
120 x 170 cm in leather, #306-120 / #307-120

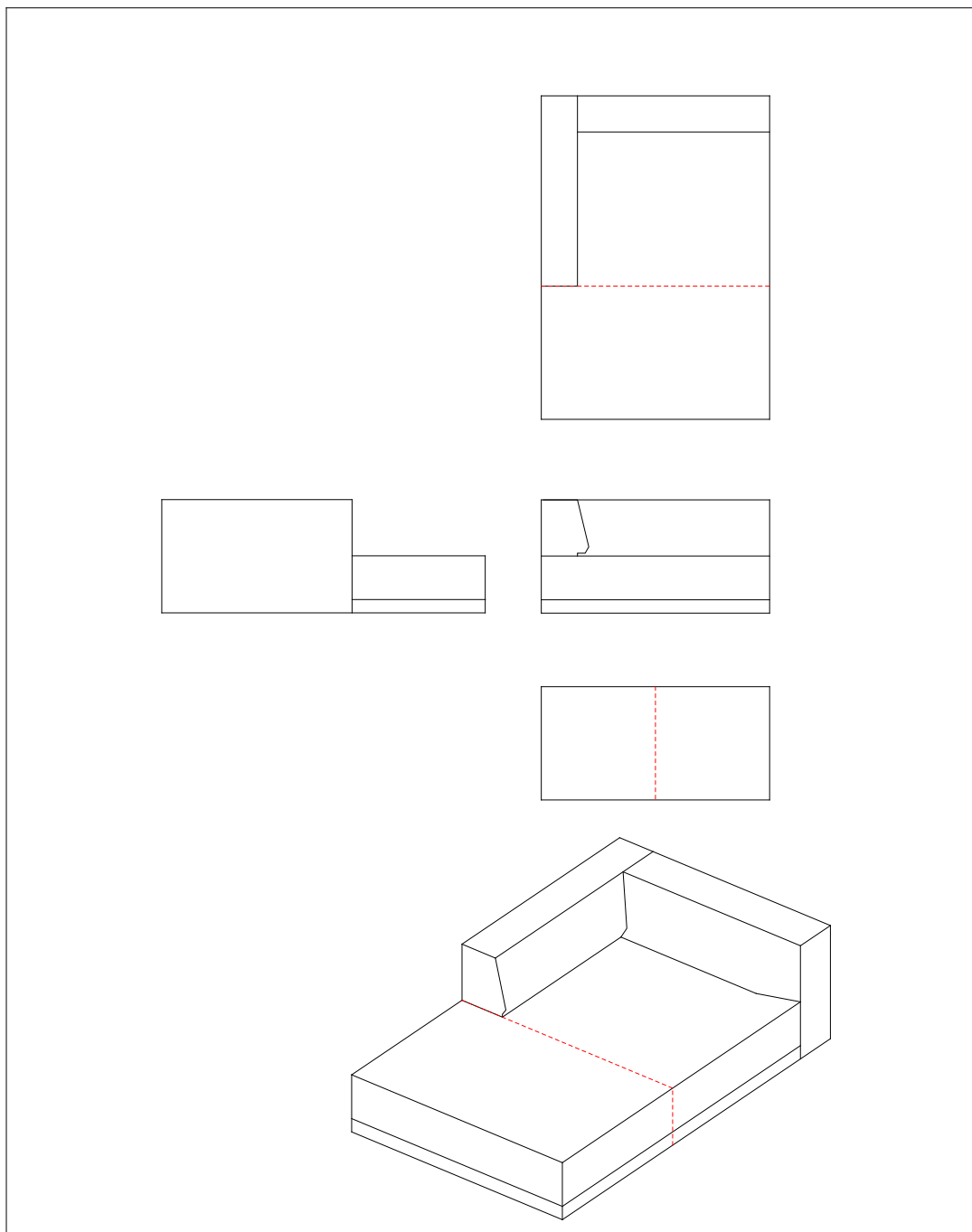

Stitching: Model RIG, chaiselong with arm, right and left,
130 x 170 cm in leather, #306-130 / #307-130

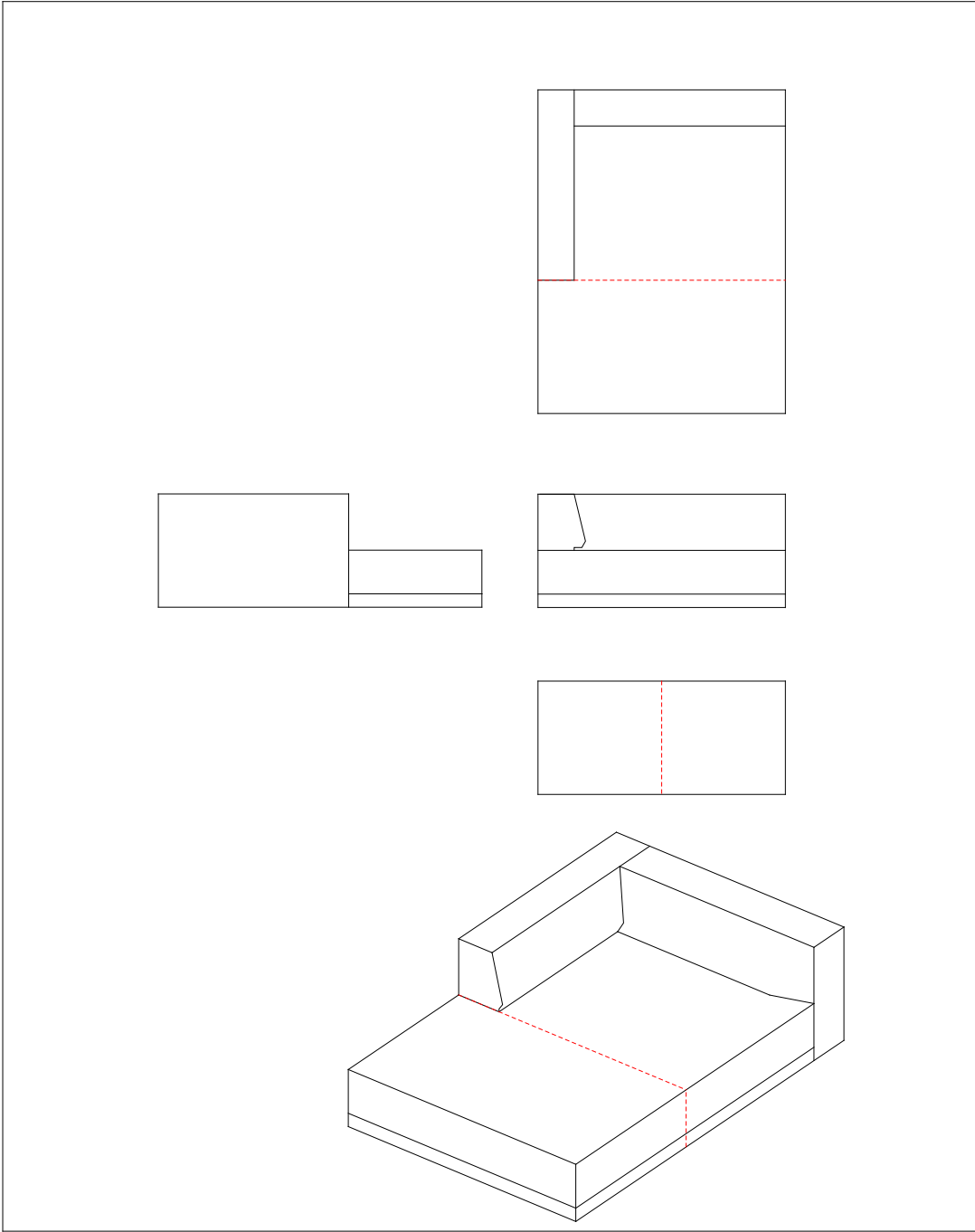

Stitching: Model RIG, chaiselong with arm, right and left,
140 x 170 cm in leather, #306-140 / #307-140

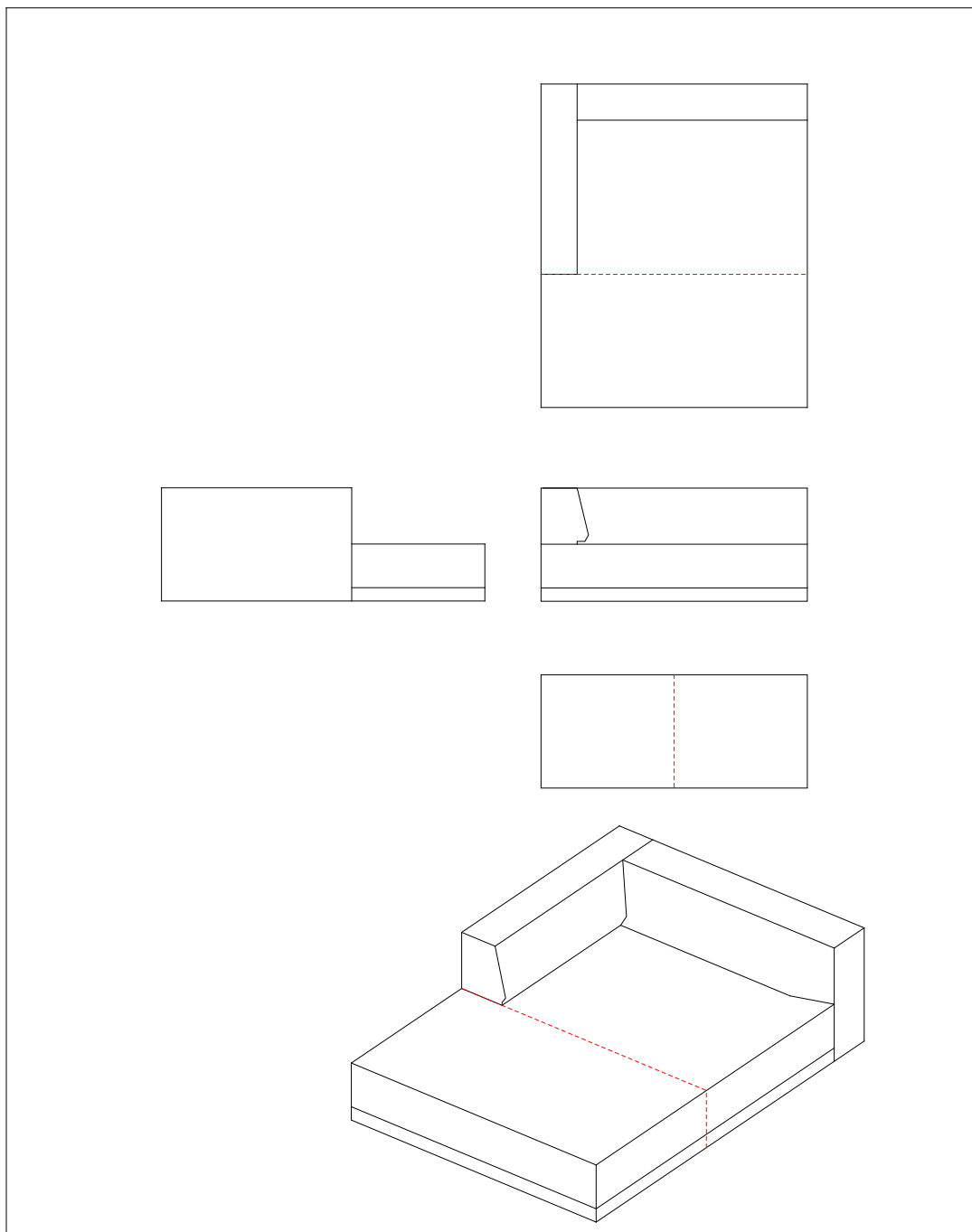

Stitching: Model RIG, chaiselong without arm, right and left,
110 x 170 cm in leather, #306U110 / #307U110

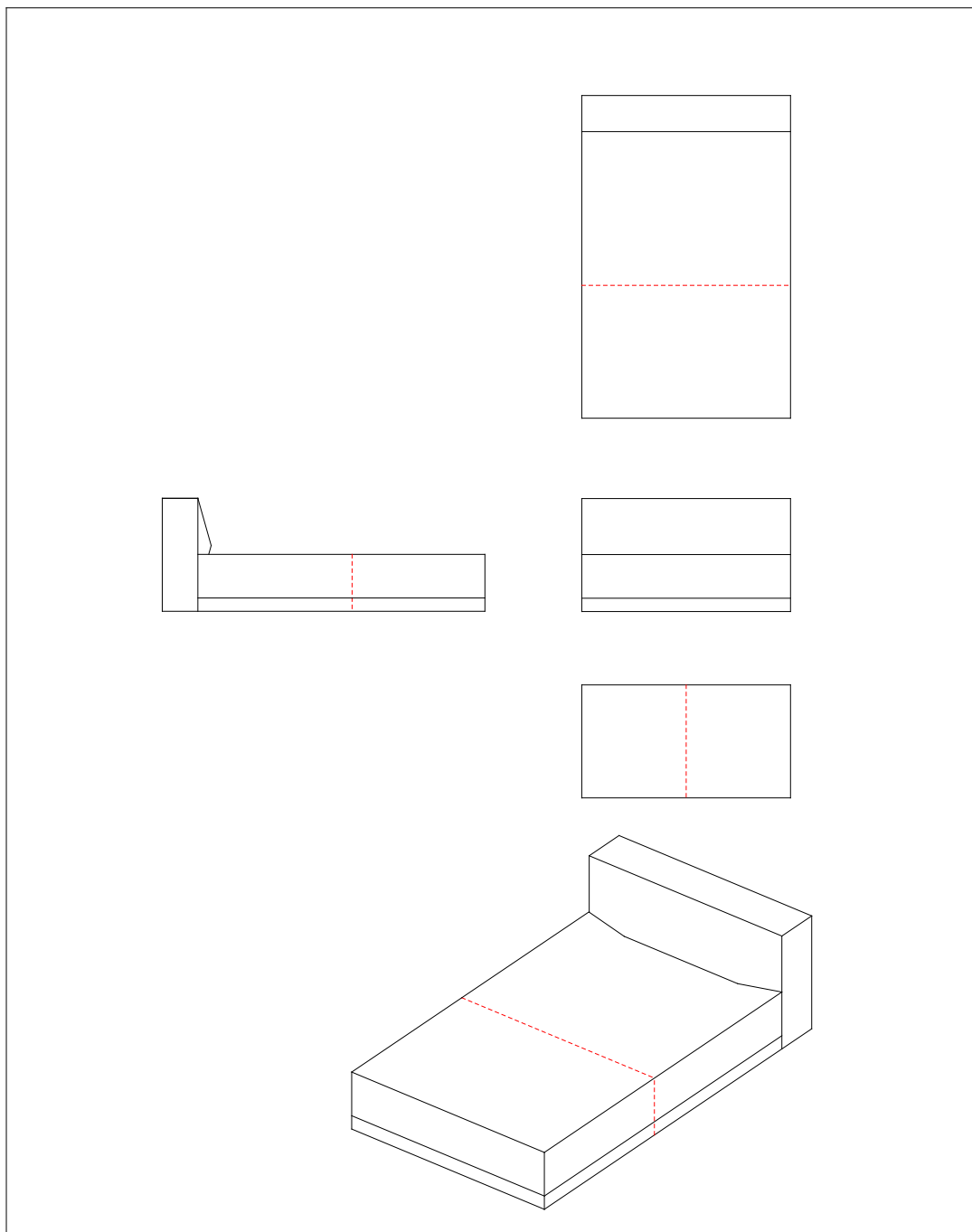

Stitching: Model RIG, chaiselong without arm, right and left,
120 x 170 cm in leather, #306U120 / #307U120

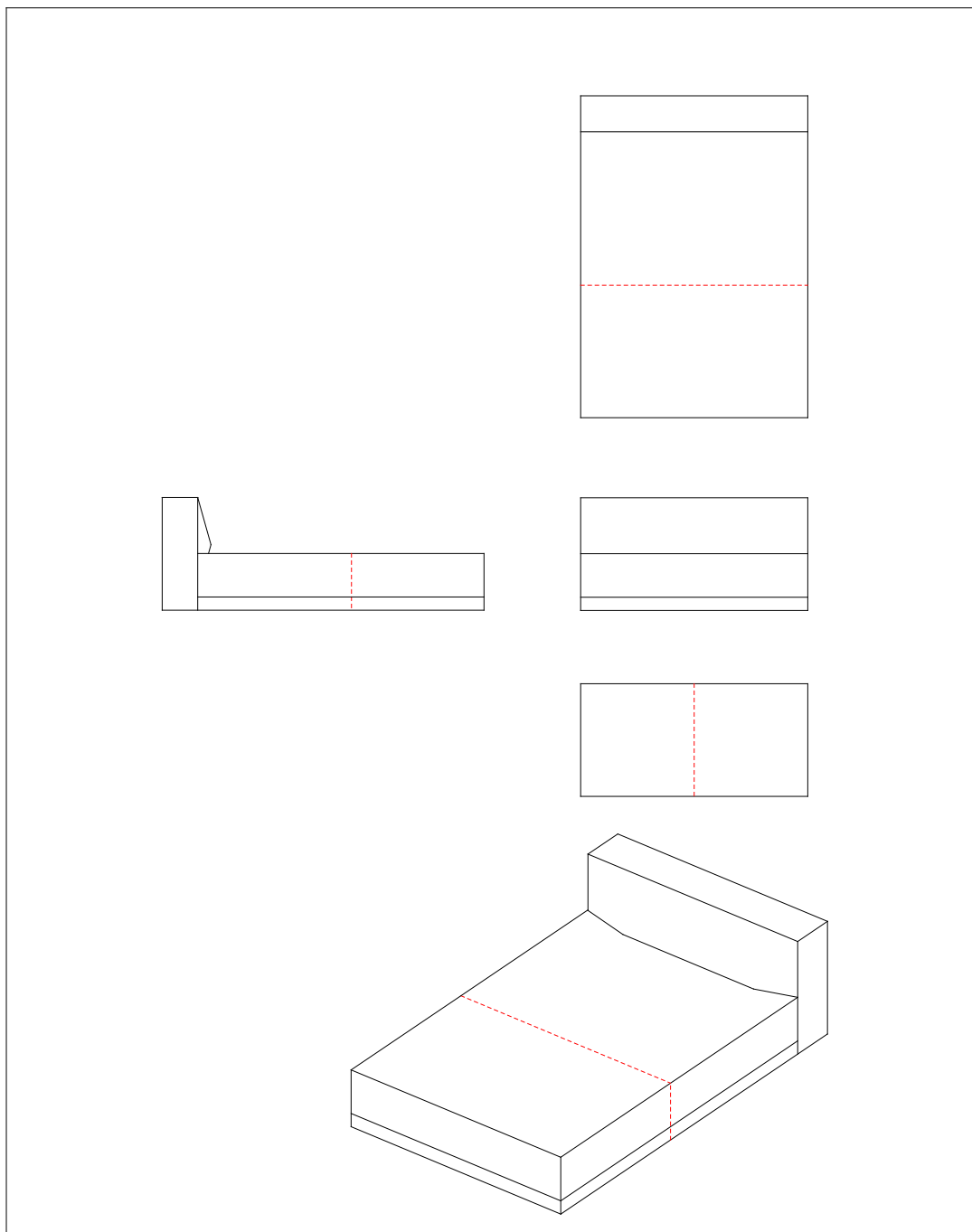

Stitching: Model RIG, chaiselong without arm, right and left,
130 x 170 cm in leather, #306U130 / #307U130

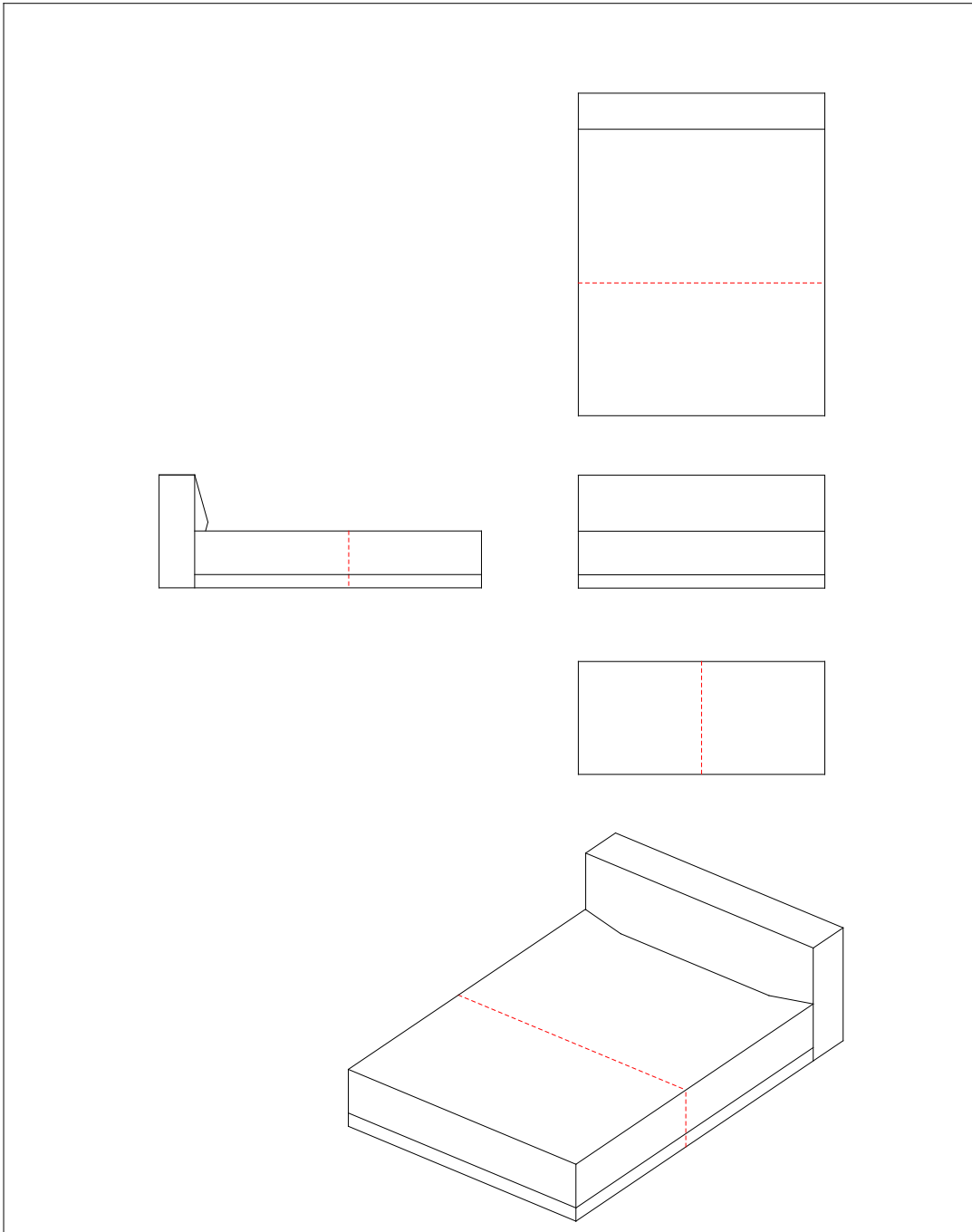

Stitching: Model RIG, chaiselong without arm, right and left,
140 x 170 cm in leather, #306U140 / #307U140

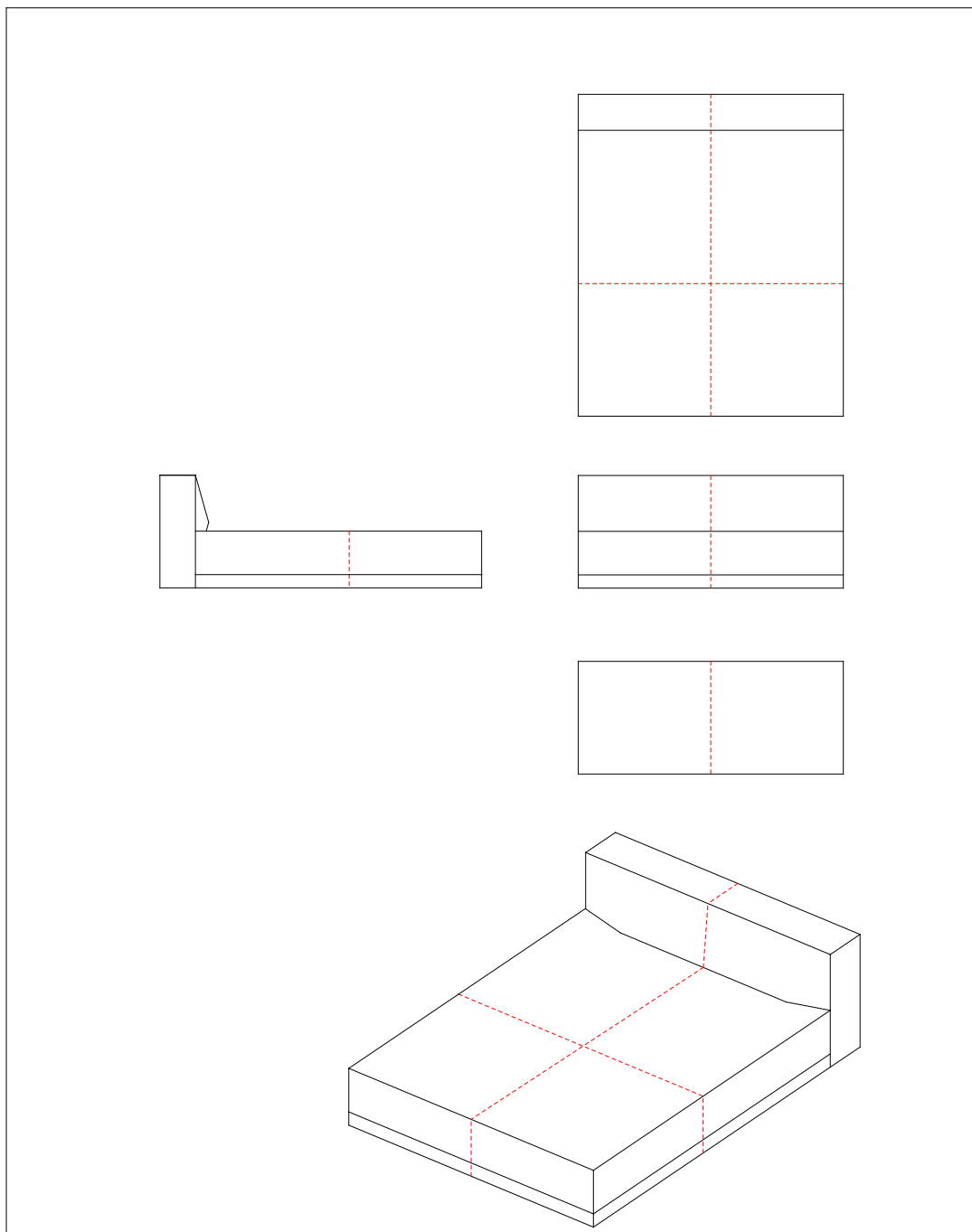

Stitching: Model RIG, footstol,
100 x 100 cm in leather, #3051010

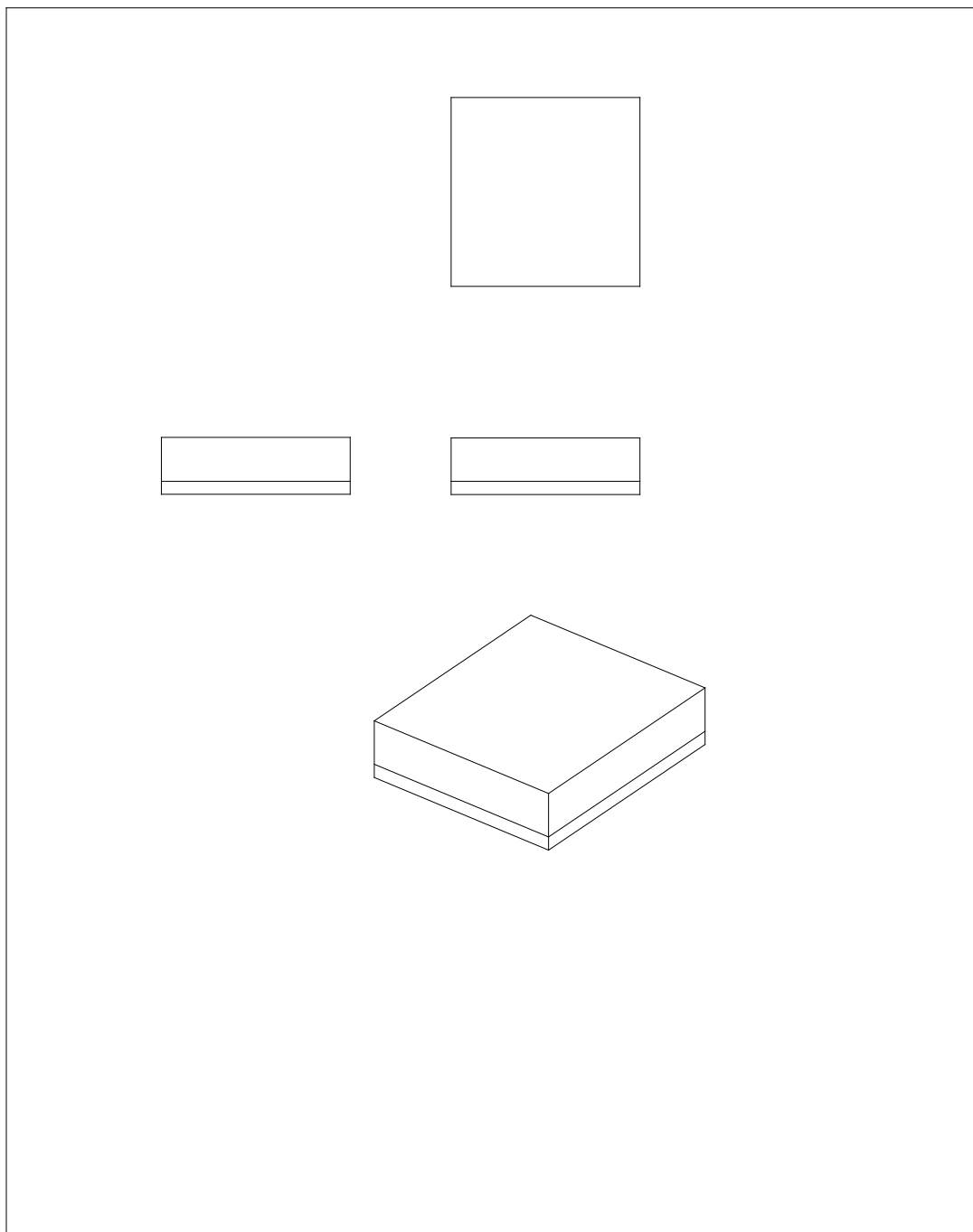

Stitching: Model RIG, footstol,
100 x 150 cm in leather, #3051015

